User Guide

RIGOL

Publication number DG3-070728

March 2007

DG3000 Series Function/Arbitrary Waveform Generator

© Copyright RIGOL Technologies, Inc. 2007

All Rights Reserved

- Copyright © **RIGOL** TECHNOLOGIES, INC. 2007 All Rights Reserved.
- RIGOL products are protected by patent law in and outside of P.R. China.
- Information in this publication replaces all that in previously corresponding materials.
- RIGOL Technologies, Inc. reserves the right to modify or change part of or all the specifications and pricing policies at company's sole decision.

NOTE: *RIGOL is the registered trademark of **RIGOL** TECHNOLOGIES, INC.*

Safety Notices

Review the following safety precautions carefully before operating the instrument to avoid any personal injury or damage to the instrument or products connected to it.

To avoid potential hazards, use the instrument in a manner only as specified by this user manual.

The instrument should be serviced by qualified personnel only.

To Avoid Fire or Personal Injury

Use proper power cord. Only the dedicated power cord of the products approved by the State should be used.

Connect and Disconnect accessories properly. Do not connect or disconnect probes or test leads while they are connected to a voltage source.

Ground the instrument This generator is grounded through the protective earthing conductor of the power cord. To avoid electric shock, the grounding conductor must be connected to earth ground. Make sure the instrument is properly grounded before connecting the input or output terminals.

Connect the probe properly. The probes' ground terminals are at the same voltage level with earth terminal of the instrument. Do not connect the ground terminals to a high voltage.

Observe All Terminal Ratings. To avoid fire or shock, observe all ratings and marks on the instrument. Follow the user manual for further rating information before making connections to the instrument.

Do not operate without Covers. Do not operate your generator with covers or panels removed.

Use Proper Fuse. Only use the fuse type and rating specified for this product.

Avoid Circuit or Wire Exposure. Do not touch exposed connections or components when

they are on.

Do not operate with suspected failures. If you suspect damage with this product, have it inspected by qualified service personnel before further operations.

Provide Proper Ventilation.

Do not operate in wet/damp conditions

Do not operate in an explosive atmosphere

Keep product surfaces clean and dry

Safety Terms and Symbols

Terms in This Manual. These terms may appear in this manual:



WARNING: Warning statements identify conditions or practices that could result in injury or loss of life.



CAUTION: Caution statements identify conditions or practices that could result in damage to this product or other property.

Terms on the Product: These terms may appear on the product:

DANGER indicates an injury hazard that may be immediately accessible.

WARNING indicates an injury hazard that may be not immediately accessible.

CAUTION indicates that a potential damage to the instrument or other property might occur.

Symbols on the Product: These symbols may appear on the Instrument:



**Hazardous
Voltage**



**Refer to
Instructions**



**Protective
earth terminal**



**Grounding
Terminal
of Chassis**



**Test
Grounding
Terminal**

Rigol DG3000 Generator at a Glance

The book covers the following 3 types of DG3000 Series Function/ Arbitrary Waveform Generators:

DG3121A、DG3101A、DG3061A

RIGOL DG3000 Series Function/ Arbitrary Waveform Generator apply the DDS technology, which can provide stable, high-precision, pure and low distortion sine signal. It also can provide 120MHz square waveform with fast rising or falling edges. Its combination of excellent system features, easiness in usage and versatile functions makes this generator a perfect solution for your job now and in the future.

DG3000 Series Function/ Arbitrary Waveform Generator have clear and simple Front-Panel. The user-friendly panel layout and instructions, versatile terminals, direct graph interface, built-in instructions and help system has greatly simplified the operation process, with the help of which, users do not have to spend a great deal of time learning and familiarizing the operation of the generator before they can use it proficiently. The built-in AM, FM, PM, and FSK modulation functions generate modulated waveform at ease, without the help of a separate modulating source. USB I/O is a standard accessory, while LAN and GPIB are Optional. Remote instructions meet the SCPI specification requirements.

From the characteristics and specifications given below, you will understand how DG3000 can satisfy your measurement requirements.

- 16+2 channels digital output module (Optional) together with the analogue channel can rebuild the most commonly used mixed signal in daily practice.
- Applying DDS technology provides precise, stable and low distortion output signal.
- 4.0' QVGA color LED display.
- 300MSa/s sampling rate, 14-bit resolution.
- Frequency characteristics:
 - Sine/ Square: 1 μ Hz to 120 MHz
 - Ramp: 1 μ Hz to 1 MHz
 - Pulse: 500 μ Hz to 50MHz
 - White Noise: 10MHz bandwidth (-3dB)
 - Arbitrary: 1 μ Hz to 25MHz
- 10 standard waveforms:

Sine, Square, Ramp, Pulse, Noise, Sinc, Exponential Rise, Exponential Fall, Cardiac and DC.

- Self-definable Arbitrary waveform.
- Multiple modulation function, various modulated waveform: AM, FM, PM, FSK, PWM, SWEEP and Burst.
- Multiple I/O: External Modulation Source, External 10 MHz Reference Input, External trigger source, waveform output, synchronous signal output, Internal 10 MHz Reference output.
- Support USB storage device. Software Updating could also be performed using USB devices.
- Utmost 1M sample points of internal waveform depth, which can rebuild or simulate any complex waveform.
- Remote control is realized using the LAN.
Support 10/100M LAN. Users can remotely visit and control signal generation through web browser.
- Multiple interfaces: USB Host & Device, RS-232, GPIB (IEEE-488), LAN.
- Support the seamless connection of DS1000 Series Digital Oscilloscopes; can directly read and rebuild the stored waveform in the oscilloscopes.
- Graph interface which shows the signal setting directly.
- 10 languages user interface and built-in help system.
- Support Chinese/ English Input.

Content

Safety Notices	II
Rigol DG3000 Generator at a Glance.....	V
Chapter 1 : Getting Start.....	1-1
General Inspection	1-2
Handle Adjustment.....	1-3
The Front/Rear Panel.....	1-4
To Set a Waveform.....	1-8
To Set Modulate/ Sweep/Burst.....	1-12
To Set Trigger/Output.....	1-15
To Use Digital Input	1-16
To Use Store/Utility/Help Function.....	1-17
Chapter 2 : Operating Your Generator	2-1
To Set Sine Signals.....	2-2
To Set Square Signals.....	2-7
To Set Ramp Signals	2-10
To Set Pulse Signals	2-13
To Set Noise Signals.....	2-17
To Set Arbitrary Signals.....	2-19
To Generate the Modulated Waveform	2-32
To Generate Sweep.....	2-42
To Generate Burst	2-46
To Store and Recall	2-50
To Set the Utility Function.....	2-64
How to Use the Built-in Help System.....	2-91
Chapter 3 : Application & Examples.....	3-1
Example 1: To generate a Sine Wave.....	3-2
Example 2: To generate a Square Wave	3-3
Example 3: To generate a Ramp Wave	3-4
Example 4: To generate a Pulse Wave.....	3-5
Example 5: To generate a Noise Wave.....	3-7
Example 6: To generate Arbitrary Waveform	3-8
Example 7: To Generate an Arbitrary Waveform	3-10
Example 8: To Generate an AM Waveform	3-12

Example 9: To Generate an FSK Waveform..... 3-14

Example 10: To Generate a PWM waveform 3-16

Example 11: To Generate a Linear Sweep Waveform 3-18

Example 12: To Generate a Burst Waveform 3-20

Chapter 4 : Prompt messages & troubleshooting 4-1

Prompting Message 4-1

Troubleshooting 4-15

Chapter 5 : Support & Service 5-1

Chapter 6 : Appendix 6-1

Appendix A: Specifications 6-1

Appendix B: DG3000 Series Accessories 6-8

Appendix C: General Care and Cleaning 6-9

Chapter 1 : Getting Start

This chapter covers the following topics:

- General Inspection
- Handle Adjustment
- The Front/rear Panel
- To Set a Waveform
- To Set Modulation/Sweep/Burst
- To Set Trigger/Output
- To Use Digital Input
- To Use Store/Utility/Help Function

General Inspection

When you get a new DG3000 Series Function/ Arbitrary Waveform Generator, you are suggested to take the following steps to inspect the instrument.

1. Inspect the shipping container for damage.

Keep the damaged shipping container or cushioning material until the contents of the shipment have been checked for completeness and the instrument been checked mechanically and electrically.

2. Check the accessories.

Accessories supplied with the instrument are listed in "Accessories" in the front of this manual.

If the contents are incomplete or damaged, please notify your **RIGOL** Sales Representative.

3. Inspect the instrument.

In case any mechanical damage or defect, or if the instrument does not operate properly or pass performance tests, notify your **RIGOL** Sales Representative.

If the shipping container is damaged, or the cushioning materials show signs of stress, notify the carrier as well as your **RIGOL** sales office. Keep the shipping materials for the carrier's inspection.

RIGOL offices will arrange for repair or replacement at **RIGOL's** option without waiting for claim settlement.

Handle Adjustment

To adjust the handle position of DG3000 Function/ Arbitrary Waveform Generator, please grip the handle by the sides and pull it outward. Then, make the handle rotate to the desired position. The operating methods are shown in the graphs below 1-1, 1-2, 1-3.

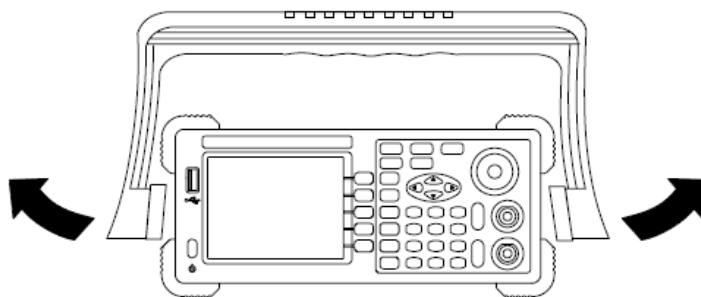

Figure 1-1 Adjust the handle

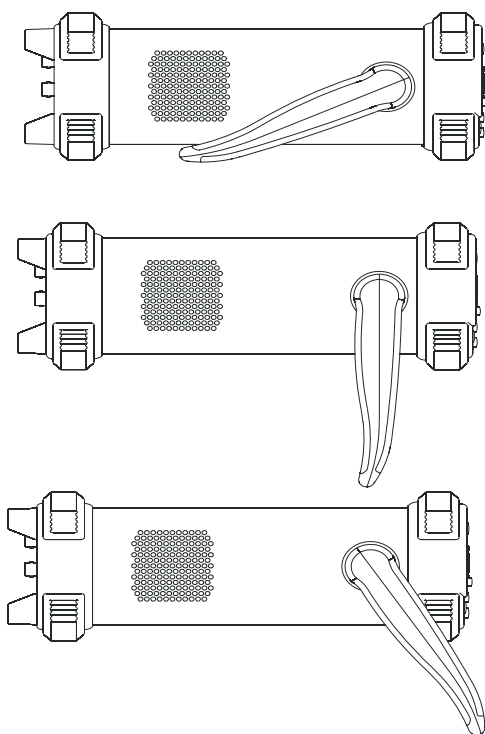

Figure 1-2
Viewing Positions

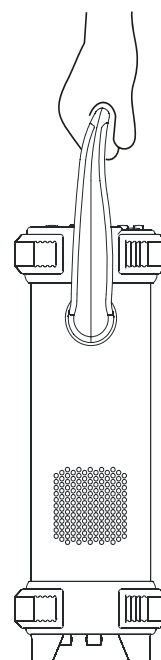

Figure 1-3
Carrying Position

The Front/Rear Panel

When you get a new DG3000 Series Function/ Arbitrary Waveform Generator, first you need to clear how to operate the front/ Rear panel correctly. This chapter will make a brief introduction and description for the operation and functions of the Front/ Rear Panel.

The Front Panel at a Glance

The DG3000 Series Function/ Arbitrary Waveform Generator has clear and simple front panel. See Figure 1-4 and 1-5. The Front Panel has a knob and functional keys. The 5 blue grey buttons on the right side of the screen are menu buttons (named F1 to F5 from up to down) with the help of which, you can enter different functions menu or have direct specific applications. The signal input and output interfaces are set at the rear panel which can help generating multiple arbitrary waveforms. The various BUS interfaces can meet the need of the multiple interface communications.

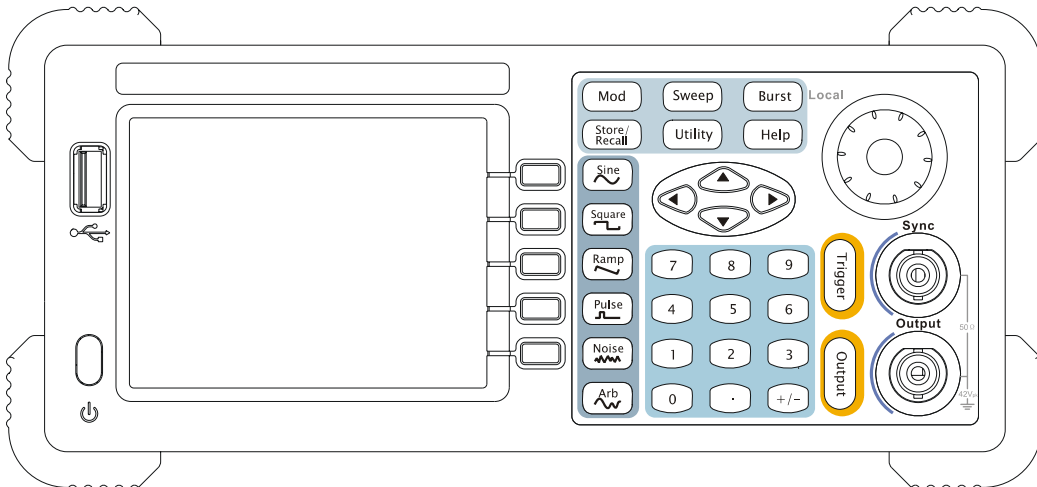

Figure 1-4
DG3000 Series Function/ Arbitrary Waveform Generator Front Panel

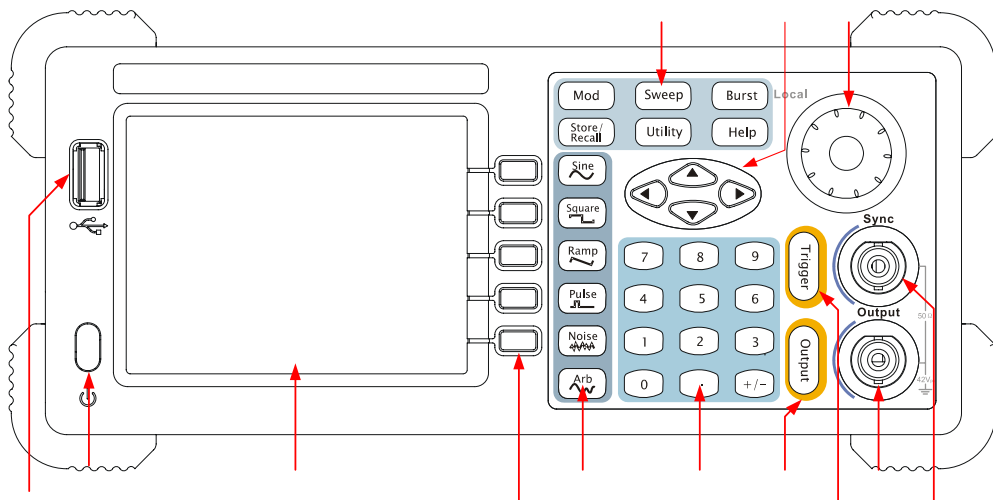

Figure 1-5
DG3000 Series Function/ Arbitrary Waveform Generator Front Panel Operation Instruction

The Rear Panel at a Glance

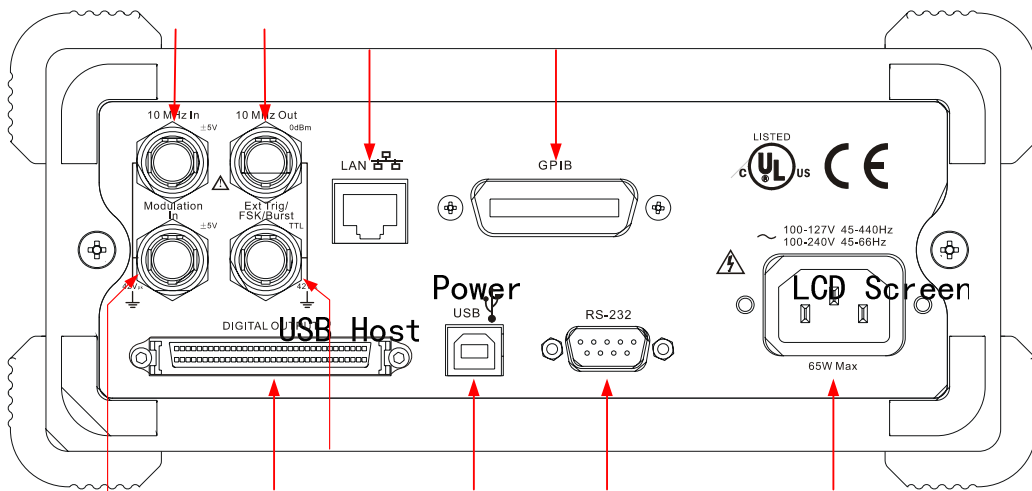

Figure 1-6
DG3000 Series Function/ Arbitrary Waveform Generator Rear Panel

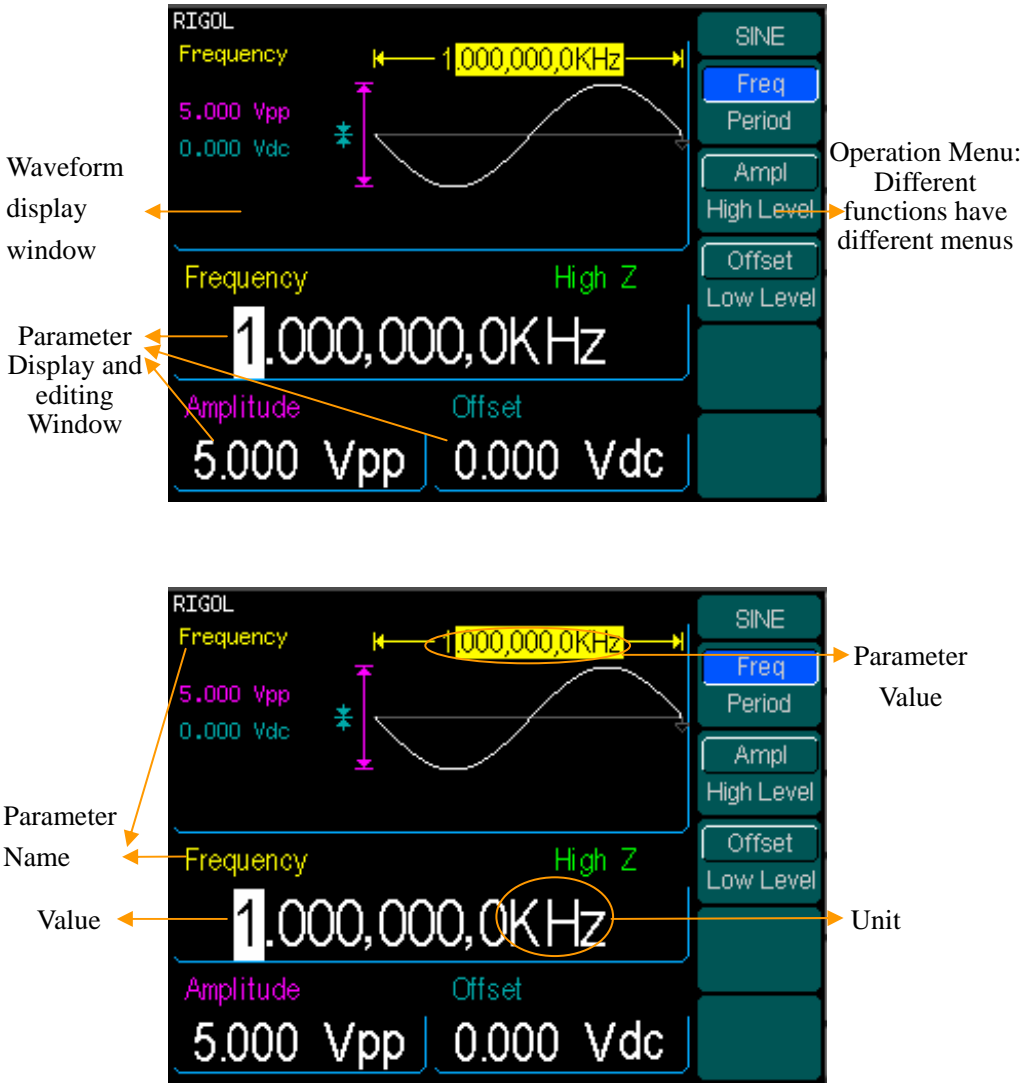





Figure 1-7
Display Interface (Sine Wave is the default display signal)

Character definitions in this User Manual:

The signs for buttons in this book are the same as the panel buttons. Please note that, the signs for the functional buttons on the operation panel are represented by squared words, such as , which represents the transparent functional key with Sine on it on the front panel, while the menu buttons are represented by darkened words such as , which means the "Frequency" option in the  menu.



Note: The main Output and Sync Channels are located in the front panel, which only allow signal output. If they are used as signal input channels, they will be burned and lead to instrument malfunction.

To Set a Waveform

On the operation panel, there is a set of buttons with waveform icon. See Figure 1-8. The exercise below will help you familiarize with the waveform selection settings.

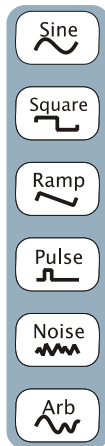

Figure 1-8
Waveform Selection Buttons

1. Press **Sine** button and the waveform window will display sine waveform. DG3000 Series Generator can generate Sine signal with a frequency from 1 μ Hz to 120MHz. Set Frequency/Period, Amplitude/ High Level, Offset/ Low level, sine signal with different parameters can be generated.

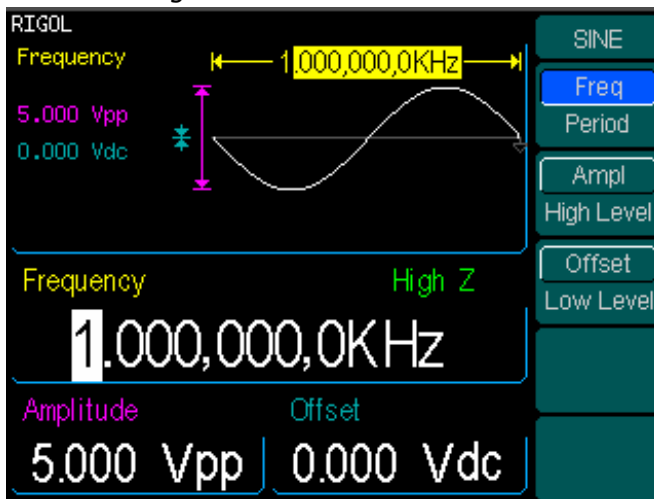

Figure 1-9
Sine Signal display interface

As shown in Figure 1-9, the default signal parameters are: 1 kHz Frequency, 5.0 Vpp Amplitude and 0Vdc Offset.

2. Press **Square** button, and the waveform window displays square waveform. DG3000 Series Generator can generate Square signal with a frequency of from 1 μ Hz to 120MHz and variable duty cycle.

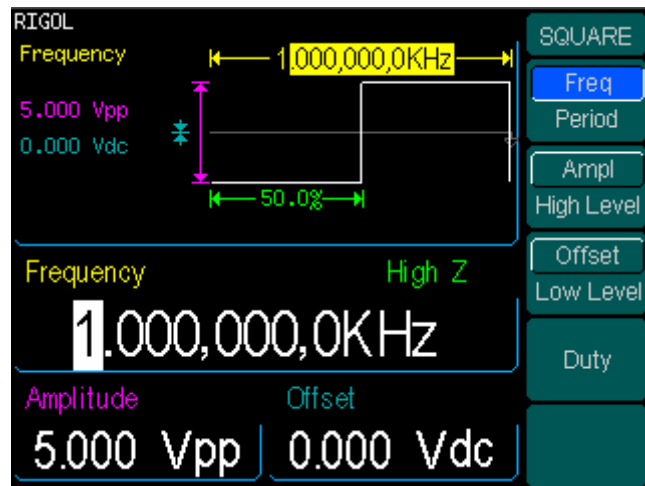

Figure 1-10
Square Signal display interface

As shown in Figure 1-10, the default signal parameters are: 1kHz Frequency, 5.0 Vpp Amplitude, 0Vdc Offset and 50% Duty Cycle.

3. Press **Ramp** button, and the waveform window displays ramp waveform. DG3000 Series Generator can generate Ramp signal with a frequency of from 1 μ Hz to 1 MHz and variable Symmetry.

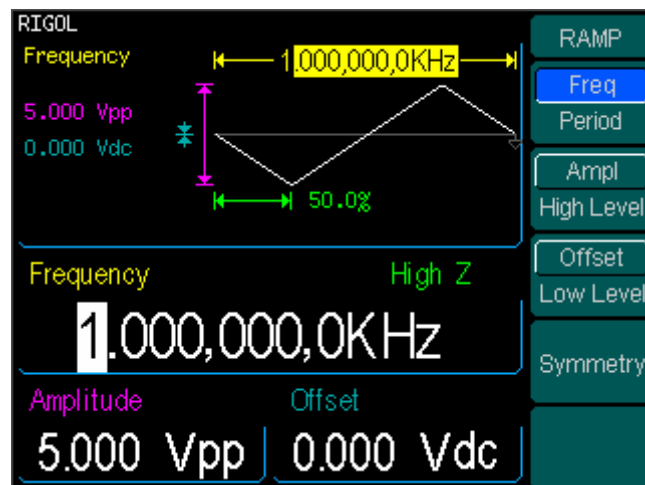

Figure 1-11

Ramp Signal display interface

As shown in Figure 1-11, the default signal parameters are: 1kHz Frequency, 5.0 Vpp Amplitude, 0Vdc Offset and 50% Symmetry.

- Press **Pulse** button, and the waveform window displays pulse waveform. DG3000 Series Generator can generate Pulse signal with a frequency of from 500μHz to 50 MHz and variable Pulse Width and Edge Time.

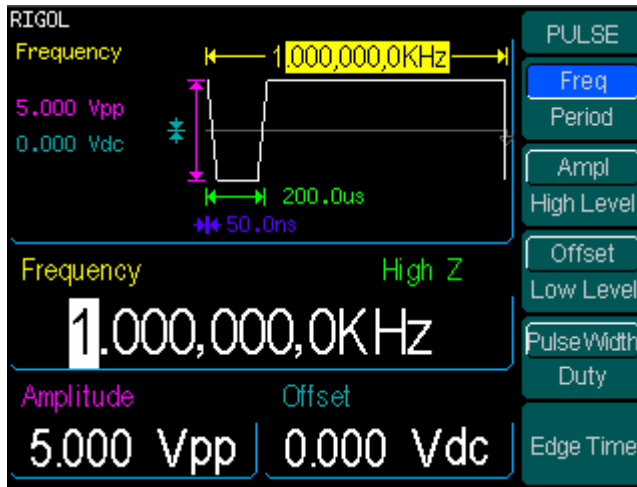

Figure 1-12

Pulse Signal display interface

As shown in Figure 1-12, the default signal parameters are: 1kHz Frequency, 5.0 Vpp Amplitude, 0Vdc Offset, 200μs Pulse Width and 50ns Edge Time.

- Press **Noise** button, and the waveform window displays noise waveform. DG3000 Series Generator can generate Noise signal with a Band Width up to 10 MHz.

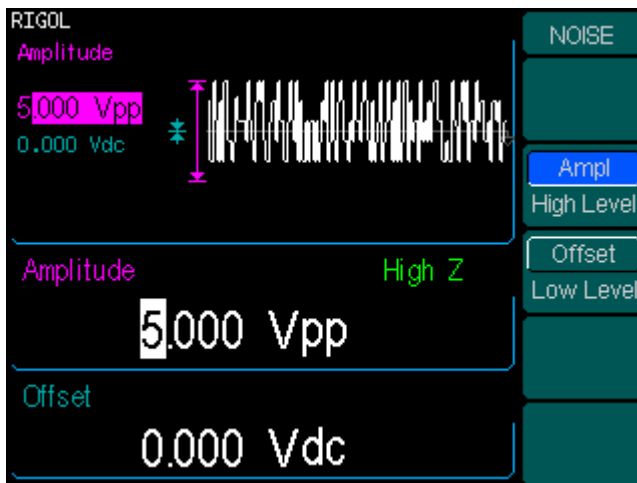

Figure 1-13
Noise Signal display interface

As shown in Figure 1-13, the default signal parameters are: 5.0 Vpp Amplitude and 0Vdc Offset.

6. Press **Arb** button, and the waveform window displays arbitrary waveform. DG3000 Series Generator can generate repeatable arbitrary waveform signals with at most 512K points and 25MHz frequency.

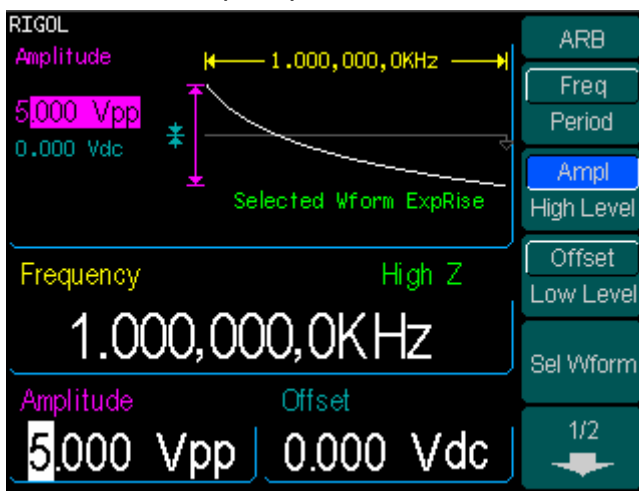

Figure 1-14
Arbitrary waveform Signal display interface

As shown in Figure 1-14, the default Exponential Rise Signal parameters are: 1kHz Frequency, 5.0 Vpp Amplitude and 0Vdc Offset.

To Set Modulate/ Sweep/Burst

As shown in Figure 1-15, there are three buttons on the front panel, which are used for Modulating, sweeping and bursting settings. The instructions below will help you familiarize with the setting of these functions.

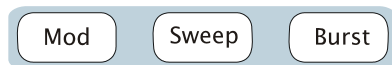

Figure 1-15
Modulate/ Sweep/ Burst button

1. Press **Mod** button, and the Modulated waveforms will be generated. The modulated waveform can be changed by modifying the parameters such as Type, Internal/ external Modulation, Depth, Frequency, Waveform, etc. DG3000 Series can modulate waveform using AM, FM, PM, and FSK. Sine, Square, Ramp or Arbitrary waveforms can be modulated (Pulse, Noise and DC can not be modulated).

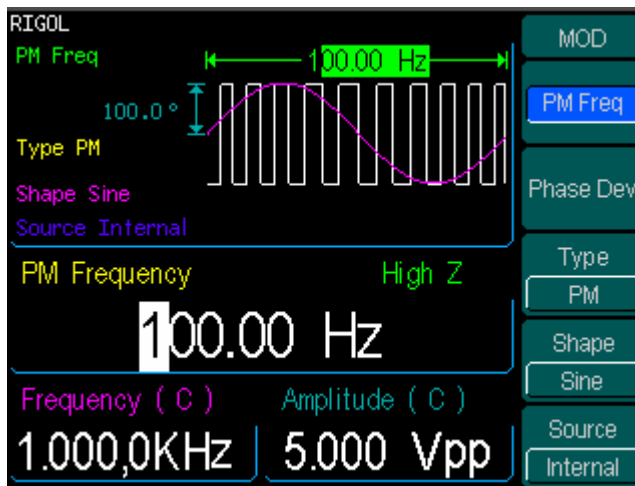

Figure 1-16
Modulated Waveform Signal display interface

- Press **Sweep** button, Sine, Square, Ramp or Arbitrary waveform can be swept (Pulse, Noise and DC can not be swept).

In the Sweep Mode, DG3000 Series generate signal with variable frequencies.

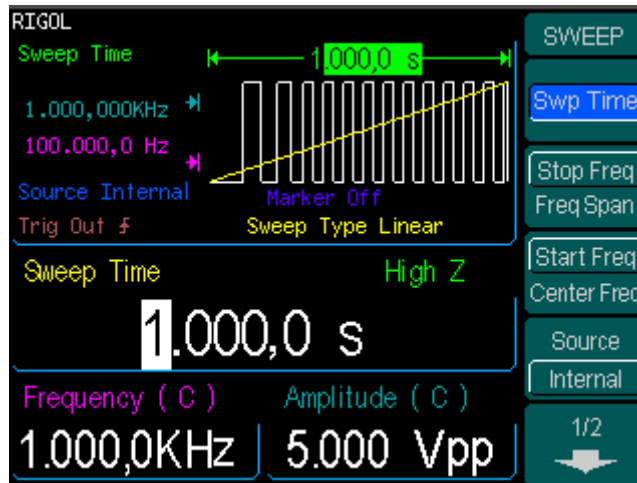

Figure 1-17

Sweep Waveform Signal display interface

- Press **Burst** button, Burst for Sine, Square, Ramp, Pulse or Arbitrary waveform can be generated (Noise can only be used in the gated Burst).

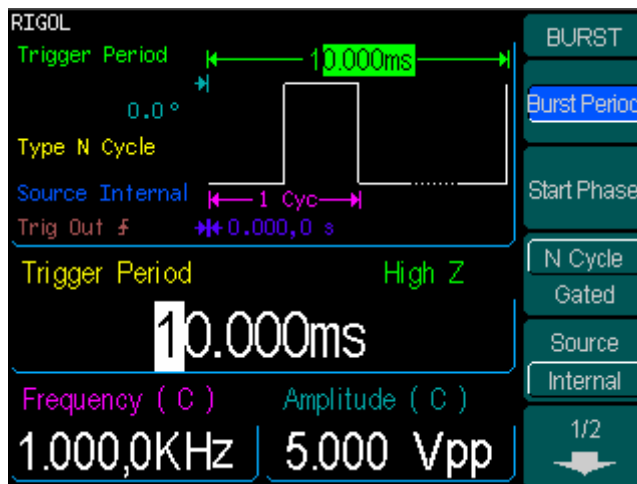

Figure 1-18

Burst Waveform Signal display interface

Term Explanation

Burst: Output Waveforms with set cycle times

Burst can last for certain times of waveform cycle (N-Cycle Burst) or be controlled by external gated signals (Gated Burst). Burst applies to all kinds of waveforms, but noise can only be used in gated burst.

To Set Trigger/Output

As shown in Figure 1-19, there are two buttons on the right side of the operation panel, which are used to set Trigger and Output Control. The instruction below will help you familiarize with these functions.



Figure 1-19
Trigger/ Output Button

1. Press **Trigger** Button, choose internal/ external or manual Trigger (Manual Trigger can only be used in Sweep and N-Cycle Burst)
 - The default setting for Trigger is "Internal". In this mode, when the Sweep or Burst Mode is also selected, the Generator will generate burst continuously. At this time, press **Trigger** button, the instrument will shift from the "Automatic" Trigger mode into "Manual" Trigger mode.
 - When the generator uses the "External" Trigger Mode, if the Sweep or the Burst Mode is selected, signal will be generated continuously. At this time, press **Trigger** button, the instrument state will not change, and it will show "The instrument has already been triggered".
 - Every time you press the **Trigger** button, "Manual" Trigger will start a sweep or generate a burst. Press the button again, and the generator will be triggered again.
2. Press **Output** Button, activate or deactivate the output signal.
If an overload message is shown, disconnect the external equipment from the output terminals and press **Output** button, reactivate the output terminal.

To Use Digital Input

As shown in Figure 1-20, there are two sets of buttons on the operation panel, which are direction button, the knob and the keypad. The instruction below will help you familiarize with the Digital Input Function.

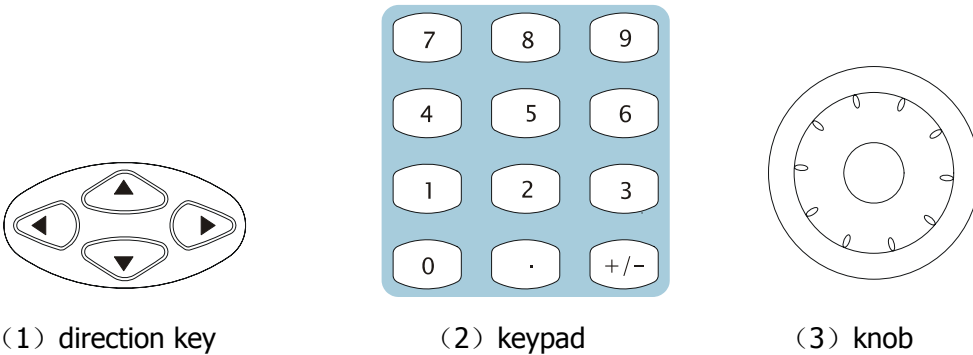

Figure 1-20

Front Panel Digital Input

1. The up and down keys are used to shift the parameters and the left and right keys are used to shift digits.
2. Keypad is used to directly set the parameters value
3. Knob is used to change a signal digit value whose range is 0~9. Clockwise to increase.

To Use Store/Utility/Help Function

As shown in Figure 1-21, there are three buttons on the operation panel, which are used to call the store/recall, utility and help function. The instruction below will help you familiarize with these Functions.



Figure 1-21
Store/Recall, Utility and Help Button

1. The **Store/Recall** Button is used to store waveform data and configure information.
2. The **Utility** Button is used to set the auxiliary system function, change the output configure parameters, interface setting, system setting information or perform the instrument self-test and read the calibration information, etc.
3. The **Help** Button is used to read the help information.

Operation Instruction

To get help on :

To get help on any key of the front panel, press and hold on that key for 1 second and the help message will appear.

Chapter 2 : Operating Your Generator

By now you have got a brief understanding about DG3000 series with the front/rear panel, every function control area and keys. You should also know how to set your function/ arbitrary waveform generator for your usage. If you are not familiar with these operations, you are suggested to read Chapter One "Getting Started" again. This chapter covers the topics listed below:

This chapter covers the following topics:

- Setting Sine Signal ()
- Setting Square Signal ()
- Setting Ramp Signal ()
- Setting Pulse Signal ()
- Setting Noise Signal ()
- Setting Arb Signal ()
- Output Modulated Signal ()
- Output Sweep Signal ()
- Output Burst Signal ()
- Trigger ()
- Store/Recall ()
- Utility Setting ()
- Help System ()

You are suggested to read this chapter carefully so as to understand DG3000 Series Generator's versatile waveform setting Functions and more operation methods.

To Set Sine Signals

Press **Sine** Button to call the Sine operation. The output Sine waveform parameters are set using the Sine operation menu.

The parameters for Sine waveforms are: Frequency/ Period, Amplitude/ High Level, Offset/ Low Level. Different Sine Signals are generated by modifying these parameters. The parameter value in the waveform display window is the same as that of in the parameter display window. As is shown in Figure 2-1, in the soft key menu, select Freq. Cursor is located in the frequency parameter area in the parameter display window. Users can set the frequency value right here. In the waveform display window, the parameter type in the left corner is frequency, the value of which is displayed in darkened color.

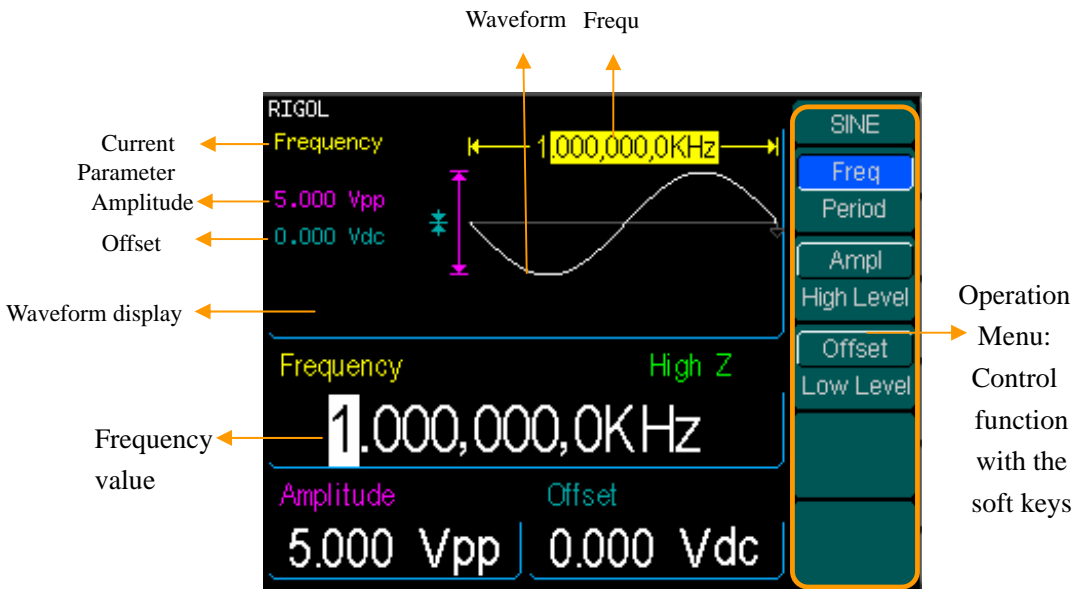

Figure 2-1
Sine Signal Parameter display Interface

Figure 2-2



Table 2-1 Sine waveform menu

Function menu	Settings	Explanations
Freq Period		Setting the signal's frequency or period; the current parameter will switch at a second press.
Ampl High Level		Setting the signal's Amplitude or High Level; the current parameter will switch at a second press.
Offset Low Level		Setting the signal's Offset or Low Level; the current parameter will switch at a second press

Instructions

The parameter type in the top left corner of Figure 2-2 is the current parameter, whose value will be displayed in darkened color.

To Set the Output Frequency/Period

(1). Press **Sine** → **Freq** , to set the frequency parameter.

The frequency shown on the screen when the instrument is powered is the default value or the set value beforehand. When setting the function, if the current value is valid for the new waveform, it will be used sequentially. If you want to set the period for the waveform, press **Freq/Period** button again, to switch to the **Period** parameter (The current operation is displayed in inverse color).

(2). Input the desired frequency.

Use the keypad to input the parameter value directly, and press the corresponding button to select the parameter unit. Or you can use the direction button to select the digit you want to edit, and then use the knob to change its value.

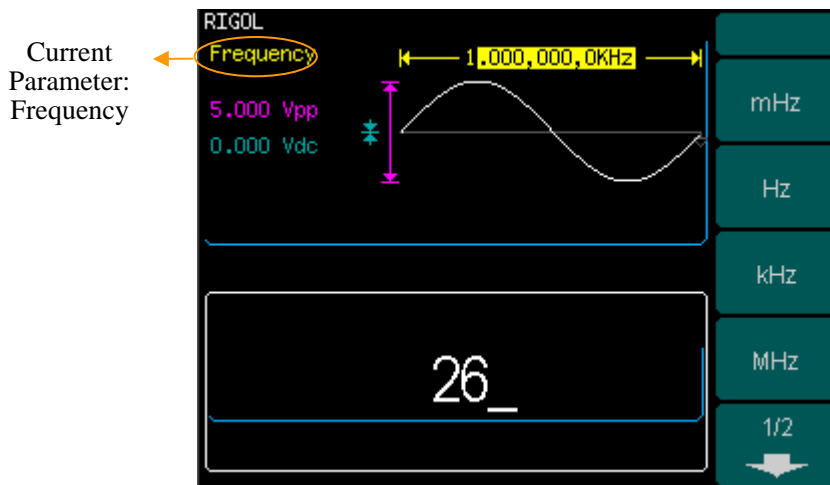

Figure 2-3
Setting the Frequency

Instruction:

When using the keypad to enter the digit, you can use the Left direction button to move the cursor backward and delete or change the value of the previous digit.

To Set the Output Amplitude

(1). Press **Sine** → **Ampl** , to set the amplitude.

The amplitude shown on the screen when the instrument is powered is the default value or the set value beforehand. When changing the function, if the current value is valid for the new waveform, it will be used sequentially. If you want to set the waveform by high Level or Low Level, press the **Ampl/High Level** or **Offset/Low level** button again, to switch into the **High Level** or **Low Level** parameter (The current operation is displayed in inverse color).

(2). Input the desired Amplitude

Use the keypad or the knob to input the desired value, choose the unit, and press the corresponding button.

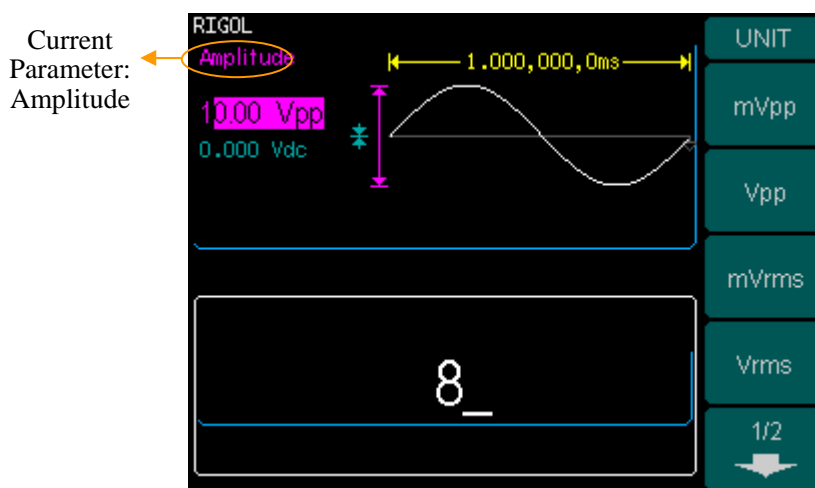

Figure 2-4
Setting the Amplitude

To Set the DC Offset

(1). Press **Sine** → **Offset** , to set the offset.

The offset shown on the screen when the instrument is powered is the default value or the set value beforehand. When changing the function, if the current value is valid for the new waveform, it will be used sequentially.

(2). Input the desired Offset

Use the keypad or the knob to input the desired value, choose the unit, and press the corresponding button.

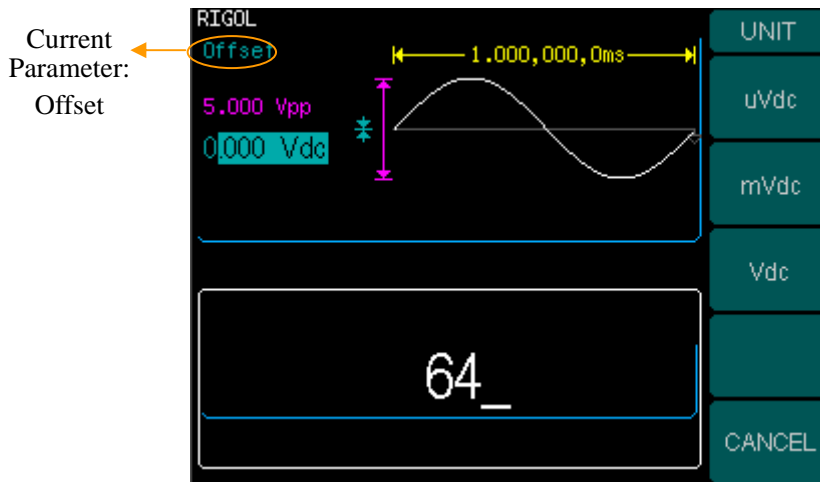

Figure 2-5
Setting the Offset

To Set Square Signals

Press **Square** button to call the Square operation. The output Square waveform parameters are set using the Square operation menu

The parameters for Square waveforms are: Frequency/ Period, Amplitude/ High Level, Offset/ Low Level and Duty Cycle. See Figure 2-6. The parameter value in the waveform display window is the same as that of in the parameter display window and the Duty Cycle value is edited directly in the waveform display window. In the soft key menu, select Duty Cycle, and the corresponding value in the waveform display window will be displayed in darken color. Users can then edit its value.

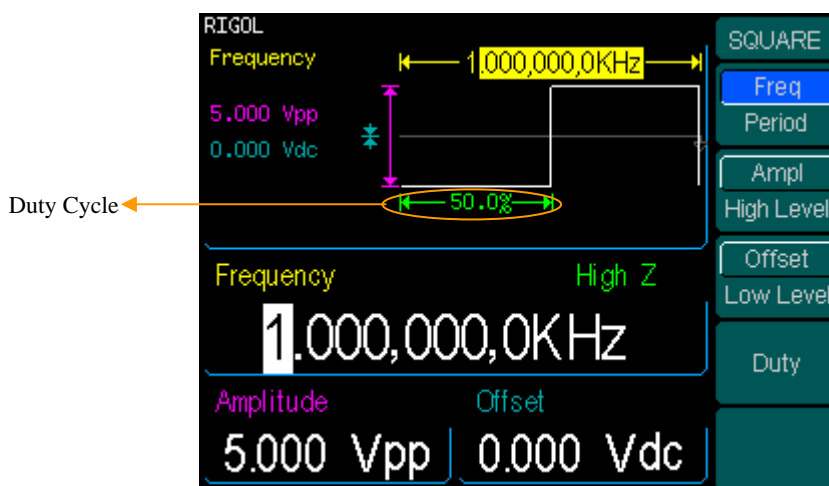

Figure 2-6

Figure 2-7



Table 2-2 Square Signal Operation Menu

Function Menu	Settings	Explanation
Freq Period		Setting the signal's frequency or period; the current parameter will switch at a second press.
Ampl High Level		Setting the signal's Amplitude or High Level; the current parameter will switch at a second press.
Offset Low Level		Setting the signal's Offset or Low Level; the current parameter will switch at a second press
Duty		Setting the Duty Cycle for Square Waveform

Term Explanation:

Duty Cycle: The percentage that the High Level takes up the whole Period.

Please Note : for the Frequency	Duty Cycle Value
Below 25MHz:	20% to 80%
From 25MHz to 50MHz (included):	40% to 60%
Higher than 50MHz:	50%

To Set the Duty Cycle

(1). Press **Square** → **Duty**, to set the Duty Cycle.

The Duty Cycle shown on the screen when the instrument is powered is the default value or the set value beforehand. When changing the function, if the current value is valid for the new waveform, it will be used sequentially.

(2). Input the desired Duty Cycle

Use the keypad or the knob to input the desired value, choose the unit, and press the corresponding button. The Generator will change the waveform immediately.

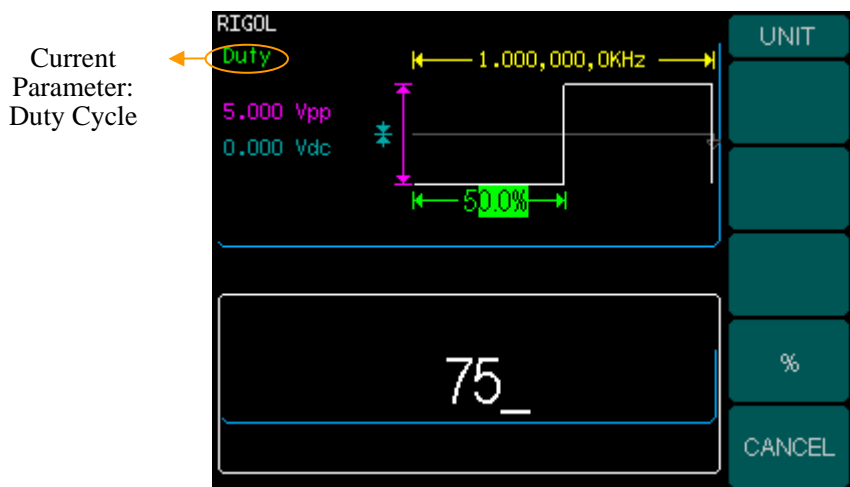

Figure 2-8
Setting the Duty Cycle

To Set Ramp Signals

Press **Ramp** button to call the Ramp operation. The output Ramp waveform parameters are set using the Ramp operation menu.

The parameters for Ramp waveforms are: Frequency/ Period, Amplitude/ High Level, Offset/ Low Level and Symmetry. See Figure 2-9. The parameter value in the waveform display window is the same as that of in the parameter display window and the Symmetry value is edited directly in the waveform display window. In the soft key menu, select Symmetry, and the corresponding value in the waveform display window will be displayed in darken color. Users can then edit its value.

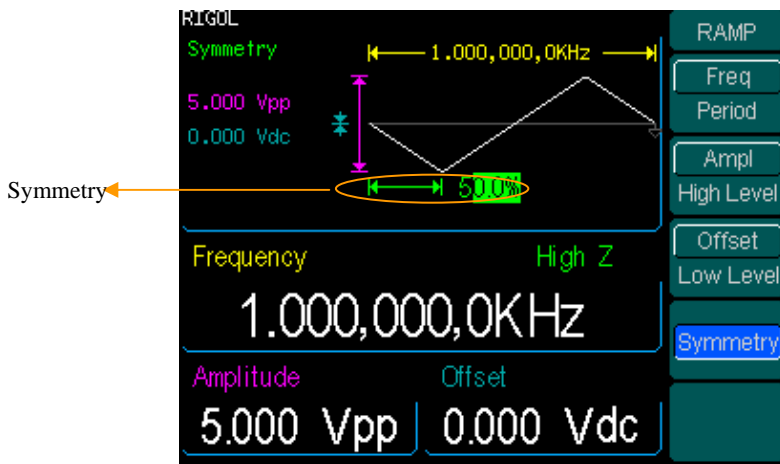

Figure 2-9
Ramp Signal Parameter Setting Interface

Figure 2-10



Table 2-3 Ramp Signal Operation Menu

Function Menu	Settings	Explanation
Freq Period		Setting the signal's frequency or period; the current parameter will switch at a second press.
Ampl High Level		Setting the signal's Amplitude or High Level; the current parameter will switch at a second press.
Offset Low Level		Setting the signal's Offset or Low Level; the current parameter will switch at a second press
Symmetry		Setting the Symmetry for Ramp Waveform

Term Explanation:

Symmetry: The percentage that the Rising Period takes up the whole Period.

Input Range: 0~100%

To Set the Symmetry

(1). Press **Ramp** → **Symmetry**, to set the Symmetry.

The Symmetry shown on the screen when the instrument is powered is the default value or the set value beforehand. When changing the function, if the current value is valid for the new waveform, it will be used sequentially.

(2). Input the desired Symmetry

Use the keypad or the knob to input the desired value, choose the unit, and press the corresponding button. The Generator will change the waveform immediately.

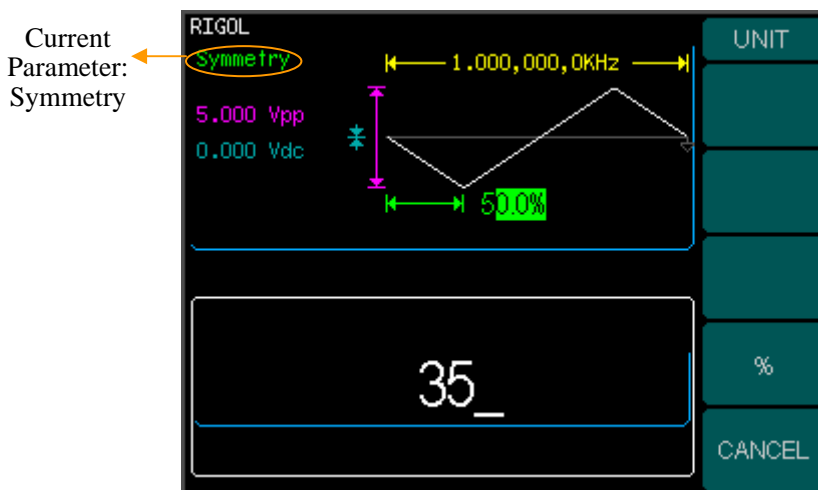

Figure 2-11
Setting the Symmetry

To Set Pulse Signals

Press **Pulse** button to call the Pulse operation. The output Pulse waveform parameters are set using the Pulse operation menu.

The parameters for Pulse waveforms are: Frequency/ Period, Amplitude/ High Level, Offset/ Low Level, Pulse Width and Edge Time. See Figure 2-12. The parameter value in the waveform display window is the same as that of in the parameter display window and the Pulse Width and the Edge Time values are edited directly in the waveform display window. In the soft key menu, select Pulse Width, and the corresponding value in the waveform display window will be displayed in darkened color. Users can then edit its value.

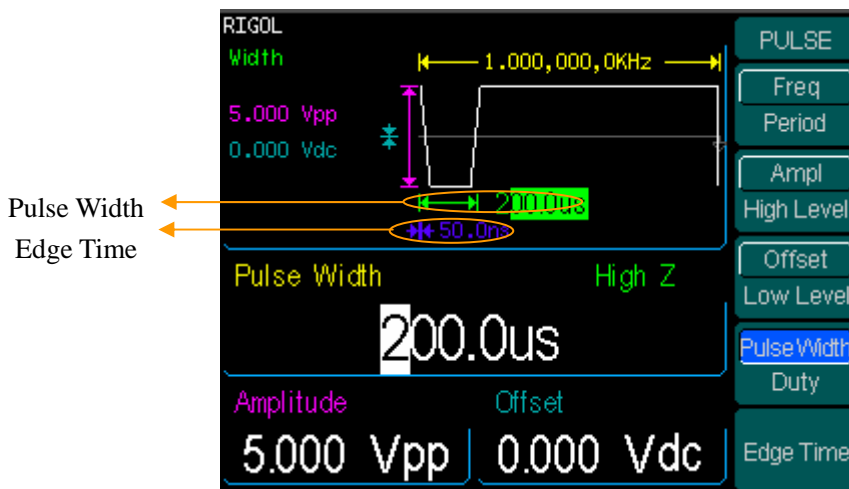

Figure 2-12

Pulse Signal Parameter Setting Interface

Figure 2-13 Table 2-4 Pulse Signal Operation Menu

<p>PULSE</p> <p>Freq Period</p> <p>Ampl High Level</p> <p>Offset Low Level</p> <p>Pulse Width Duty</p> <p>Edge Time</p>	Function Menu	Settings	Explanation
	Freq Period		Setting the signal's frequency or period; the current parameter will switch at a second press.
	Ampl High Level		Setting the signal's Amplitude or High Level; the current parameter will switch at a second press.
	Offset Low Level		Setting the signal's Offset or Low Level; the current parameter will switch at a second press
	Pulse Width		Setting the Pulse Width for Pulse Waveform
	Edge Time		Setting the Edge Time for Pulse Waveform

Term Explanation:

Pulse Width: The time span between thresholds of 50% of the rising edge amplitude to the next 50% of the falling edge amplitude.

Edge Time:

The time span between the thresholds of the 10% to 90% of the rising edge amplitude is called Rising Time.

The time span between the thresholds of the 90% to 10% of the falling edge amplitude is called Falling Time.

The Rising Time and the Falling Time together called Edge Time.

To Set the Pulse Width

(1). Press **Pulse** → **Pulse Width**, to set the Pulse Width.

The Pulse Width shown on the screen when the instrument is powered is the default value or the set value beforehand. When changing the function, if the current value is valid for the new waveform, it will be used sequentially.

(2). Input the desired Pulse Width

Use the keypad or the knob to input the desired value, choose the unit, and press the corresponding button. The Generator will change the waveform immediately.

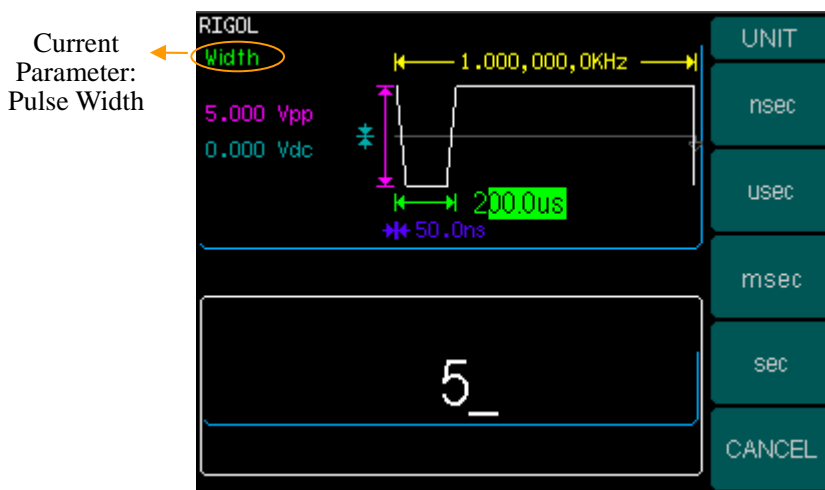

Figure 2-14
Setting the Pulse Width

To Set the Edge Time

(1). Press **Pulse** → **Edge Time**, to set the Edge Time.

The Edge Time shown on the screen when the instrument is powered is the default value or the set value beforehand. When changing the function, if the current value is valid for the new waveform, it will be used sequentially.

(2). Input the desired Edge Time

Use the keypad or the knob to input the desired value, choose the unit, and press the corresponding button. The Generator will change the waveform immediately.

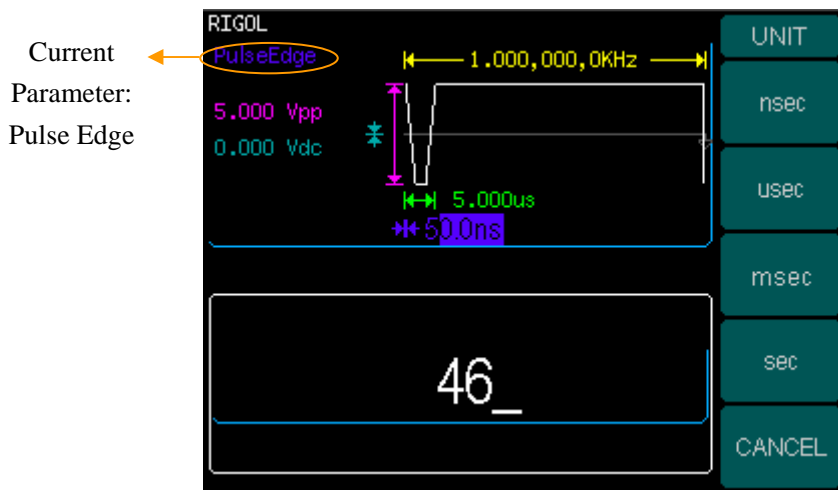

Figure 2-15
Setting the Edge Time

Instruction:

The default setting is the same Edge Time for Rising and Falling Edges.

To Set Noise Signals

Press **Noise** button to call the Noise operation. The output Noise waveform parameters are set using the Noise operation menu.

The parameters for Noise waveforms are: Amplitude/ High Level and Offset/ Low Level. See Figure 2-16. The parameter value in the waveform display window is the same as that of in the parameter display window. In the soft key menu, select Offset, and the corresponding value in the waveform display window will be displayed in darken color. Users can then edit its value. Noise is non-regulated signal which has no frequency or period.

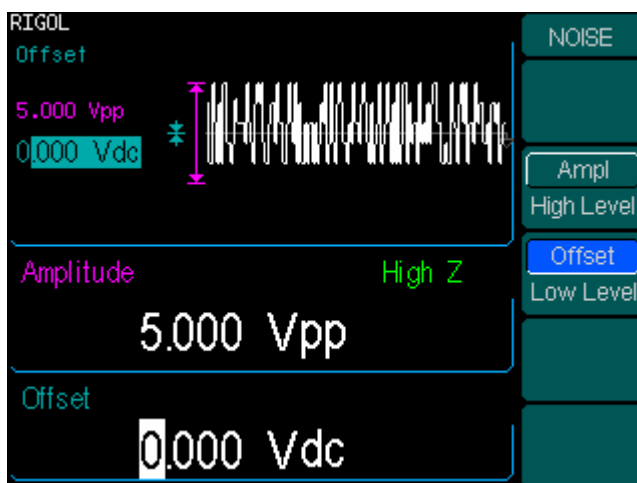

Figure 2-16
Noise Signal Parameter Setting Interface

Figure 2-17 Table 2-5 Noise Signal Operation Menu



Function Menu	Settings	Explanation
Ampl High Level	/	Setting the signal's Amplitude or High Level; the current parameter will switch at a second press.
Offset Low Level	/	Setting the signal's Offset or Low Level; the current parameter will switch at a second press

To Set Arbitrary Signals

Press **Arb** button to call the Arb operation. The output Arb waveform parameters are set using the Arb operation menu.

The Arb signal consists of two types: the system built-in waveform and the user-definable waveform. The parameters for Arb waveforms are: Frequency/ Period, Amplitude/ High Level and Offset/ Low Level. See Figure 2-18. The parameter value in the waveform display window is the same with that of in the parameter display window. In the soft key menu, select Amplitude, and the corresponding value in the waveform display window will be displayed in darken color. Users can then edit its value.

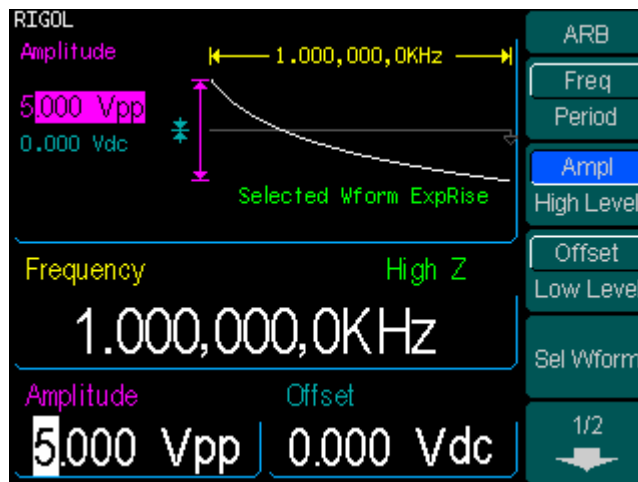

Figure 2-18
Arbitrary Signal Parameter Setting Interface

Figure 2-19



Table 2-6 Arbitrary Signal Operation Menu

Function Menu	Settings	Explanation
Freq Period		Setting the signal's frequency or period; the current parameter will switch at a second press.
Ampl High Level		Setting the signal's Amplitude or High Level; the current parameter will switch at a second press.
Offset Low Level		Setting the signal's Offset or Low Level; the current parameter will switch at a second press
Sel Wform		Select the built-in Arbitrary Signal as Output
Edit Wform		Create and Edit Arbitrary Waveform

To Select the built-in Arbitrary Waveform

There are five built-in Arbitrary Waveforms and user-definable Arbitrary Waveforms inside the Generator. To select one of them, follow the instructions below:

Press **Arb** → **Load**, to enter the interface shown below.

Figure 2-20 Table 2-7 Selection Menu for Built-in Arbitrary Waveform

ARB	Function Menu	Settings	Explanation
Built-In	Built-in		Select one of the five built-in Arbitrary Waveforms (See Table 2-8)
Stored Wforms	Stored Wform		Select one of Arbitrary Waveforms stored in the Non-volatile memory
Volatile Wform	Volatile Wform		Select one of Arbitrary Waveforms stored in the Volatile memory. When a new waveform is created, the old one will be erased.
DELETE Wform	DELETE Wform		Delete one of the Arbitrary Waveforms stored in the Non-volatile memory. The five Built-in Waveforms can not be deleted.
CANCEL	CANCEL		Cancel the current operation, and return to the upper menu. (The rest are the same and will not be covered)

Instructions:

1. When there is no waveform stored in the Non-Volatile Memory, the **Stored** Menu and the **Delete** Menu will hide.
2. When there is no waveform in the Volatile Memory, the **Volatile** menu will hide.

1. To Select the Built-in Waveform

Press **Arb** → **Sel Wform** → **Built-In**, and enter the following interface.

Figure 2-21(1) Table 2-8(1) The Built-in Arbitrary Waveforms Menu



Function Menu	Settings	Explanation
ExpRise		Select the built-in Exponential Rise Waveform
ExpFall		Select the built-in Exponential Fall Waveform
NegRamp		Select the built-in Negative Ramp Waveform
Sinc		Select the built-in Sinc Waveform. $Sinc = \sin(x)/x$
1/2		Enter next page (the rest is the same)

Figure 2-21(2) Table 2-8(2) The Built-in Arbitrary Waveforms Menu

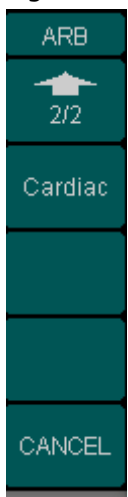

Function Menu	Settings	Explanation
2/2		Return previous page (the rest is the same)
Cardiac		Select the built-in Cardiac Waveform

2. To Select the Stored Waveform

Press **Arb** → **Sel Wform** → **Stored Wform** , and enter the following interface.

Figure 2-22(1) Table 2-9(1) The Stored Arbitrary Waveform Menu

ARB	Arb Mem1	Arb Mem2	Arb Mem3	Arb Mem4	1/2 ↓
Function Menu	Settings	Explanation			
ARB Mem1		Select the Arb Waveform stored in the non-Volatile Memory. The location is: C:\ARB1:ARB_1			
ARB Mem 2		Select the Arb Waveform stored in the non-Volatile Memory. The location is: C:\ARB2:ARB_2			
ARB Mem 3		Select the Arb Waveform stored in the non-Volatile Memory. The location is: C:\ARB3:ARB_3			
ARB Mem 4		Select the Arb Waveform stored in the non-Volatile Memory. The location is: C:\ARB4:ARB_4			

Figure 2-22(2) Table 2-9(2) The Stored Arbitrary Waveform Menu

ARB	2/2 ↑	Select Arb	CANCEL
Function Menu	Settings	Explanation	
Select Arb		Open the selected waveform	

Instructions:

When there is no waveform stored in the **Arb Mem1** 、 **Arb Mem2** 、 **Arb Mem3** and **Arb Mem4**, this menu will hide (The rest is the same and will not be covered)

3. To Remove the Waveform

Press **Arb** → **Sel Wform** → **DELETE Wform** , and enter the following interface.

Figure 2-23(1)

Table 2-10(1) The Stored Arbitrary Waveform Menu



Function Menu	Settings	Explanation
ARB Mem1		Select the Arb Waveform stored in the non-Volatile Memory. The location is: C:\ARB1:ARB_1
ARB Mem 2		Select the Arb Waveform stored in the non-Volatile Memory. The location is: C:\ARB2:ARB_2
ARB Mem 3		Select the Arb Waveform stored in the non-Volatile Memory. The location is: C:\ARB3:ARB_3
ARB Mem 4		Select the Arb Waveform stored in the non-Volatile Memory. The location is: C:\ARB4:ARB_4

Figure 2-23(2)

Table 2-10(2) The Stored Arbitrary Waveform Menu



Function Menu	Settings	Explanation
Delete Arb		Delete the selected waveform

To Edit the Arbitrary Waveform

The Generator allows users to edit Arbitrary Waveforms, which can create any new waveform by initializing points. The procedure is as follows:

Press **Arb** → **EditWform**, to enter the interface shown below.

Figure 2-24 Table 2-11 Waveform Edition Operation Menu

EditW	Function Menu	Settings	Explanation
Create New	Create New		Create a new waveform, and erase the waveform in the Volatile memory.
Edit Volatile	Edit Stored		Edit the waveform stored in the non-Volatile memory
	Edit Volatile		Edit the waveform stored in the Volatile memory
CANCEL	DELETE Wform		Delete one of the Arbitrary Waveforms stored in the Non-volatile memory. The five Built-in Waveforms can not be deleted.

Instructions:

1. When there is no waveform stored in the Non-Volatile Memory, the **Edit Stored** Menu and the **DELETE Wform** Menu will hide.
2. When there is no waveform in the Volatile Memory, the **Edit Volatile** menu hide

1. To Create a New Waveform

Press **Arb** → **EditWform** → **Create New** , to set the overall parameter for the waveform. Interface is shown in Figure 2-25 and menu in Table 2-12.

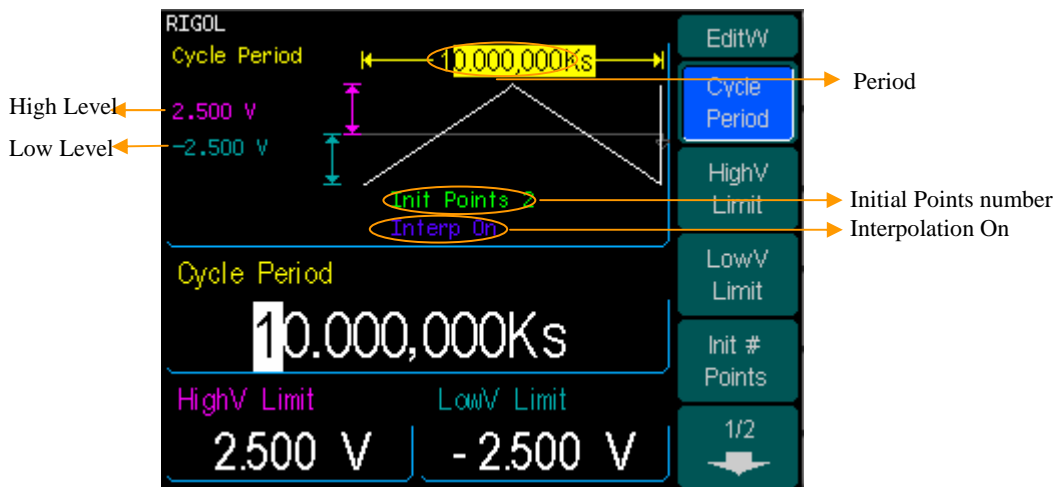

Figure 2-25
Interface for setting the new waveform parameter

Figure 2-26(1)

Table 2-12(1) Setting the parameter for the new waveform



Function Menu	Settings	Explanation
Cycle Period		Setting the Cycle Period for the Waveform
HighV Limit		Setting the Level High Limit for the Waveform
LowV Limit		Setting the Level Low Limit for the Waveform
Int# Points		Set the number of initial points when Initializing the waveform

Figure 2-26(2) Table 2-12(2) Setting the parameter for the new waveform



Function Menu	Settings	Explanation
Interp	On Off	Activate the linear Interpolation between the defined points Deactivate the linear Interpolation between the defined points
Edit Points		Turn on the Waveform Editor

To Set the Point Number

Press **Int #Points**, to set the number of the initializing points

When a new waveform is created, the waveform editor will firstly create a waveform with two points. The Waveform Editor connects the last point to the Voltage Level of point #1 automatically to create a continuous waveform. A waveform with at most 512X1024 points can be created.

In the default setting, point #1 is Level High, fixed on 0 second, while point #2 is Level Low and on the half of the set Cycle period.

To Set the Interpolation

Press **Interp.On**, if you choose **Interpolation On**, and the points will be connected with beelines; otherwise, the voltages between two consecutive points will not change, and waveform looks like a step-up one.

To Edit the Waveform Points

Press **Arb** → **Edit Wform** → **Create New** → **Edit Points**, The waveform can be defined by setting the time and voltage for each point using this function. The menu is as follows:

Figure 2-27(1)

Table 2-13(1) Waveform Parameter Edition Menu



Function Menu	Settings	Explanation
Point#		Select the point to be edited
Voltage		Set Voltage for the Selected point
Time		Set time for the Selected point
Insert		Insert a new point between the defined points. Use the "Time" and "Voltage" to define the new point.

Figure 2-27(2)

Table 2-13(2) Waveform Parameter Edition Menu



Function Menu	Settings	Explanation
Remove		Remove the current point
Stored in Non-Vol		Save the created waveform to the non-Volatile Memory. Resort to Table 2-14for a detailed Storage Catalogue
Done		Finish the current operation and return to the first level menu. (The rest is the same and will not be covered)

Instruction:

The time for the last definable point should be less than the cycle period in the waveform.

Save the Waveform to the Non-Volatile Memory

Press **Arb** → **Edit Wform** → **Create New** → **Edit Points** → **Store in Non-Vol** , to enter the following interface.

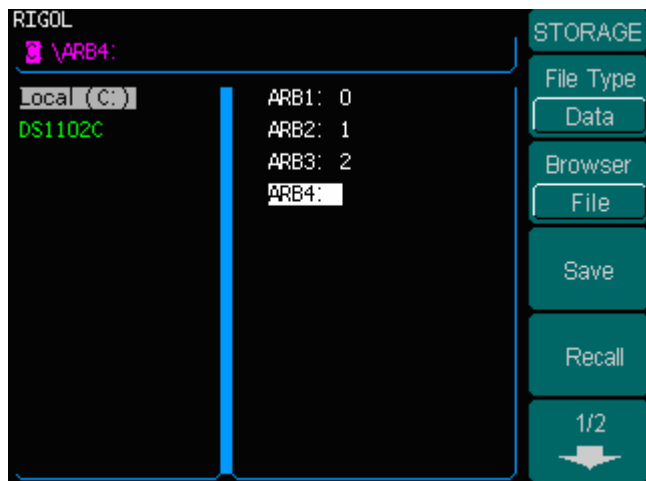

Figure 2-28(1) choose the location

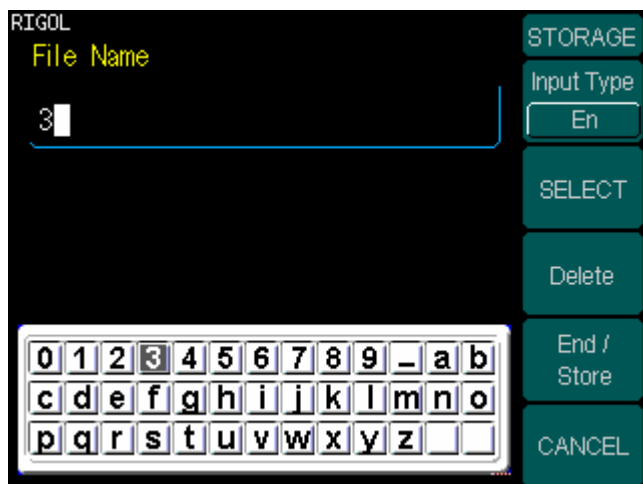

Figure 2-28(2) input the name

Table 2-14 Save New Waveform Menu

Function Menu	Settings	Explanation
File ARB1		Store the waveform to ARB1 location and name the file. Press Finish/Done to finish the operation.
File ARB 2		Store the waveform to ARB2 location and name the file. Press Finish/Done to finish the operation.
File ARB 3		Store the waveform to ARB3 location and name the file. Press Finish/Done to finish the operation.
File ARB 4		Store the waveform to ARB4 location and name the file. Press Finish/Done to finish the operation.

Instruction

To save the Arbitrary Waveform:

In the Non-volatile Memory, each waveform storage place saves only one waveform. If a new one is stored, the old one will be erased.

- ✧ For a waveform containing points less than 128K, one place will be used.
- ✧ For a waveform containing points from 128K to 256K, two sequential places will be used.
- ✧ For a waveform containing points from 256K to 512K, All the 4 places will be used.

2. To Edit the Stored Waveform

Press **Arb** → **Edit Wform** → **Edit Stored**, to enter the following interface.

Figure 2-29(1) Table 2-15(1) Edit Stored Waveform Menu

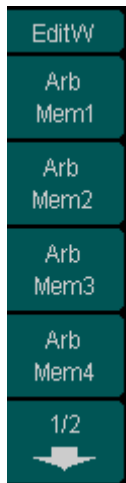

Function Menu	Settings	Explanation
ARB Mem1		Select the Arb Waveform stored in the non-Volatile Memory. The default location is: C:\ARB1:ARB_1
ARB Mem 2		Select the Arb Waveform stored in the non-Volatile Memory. The default location is: C:\ARB2:ARB_2
ARB Mem 3		Select the Arb Waveform stored in the non-Volatile Memory. The default location is: C:\ARB3:ARB_3
ARB Mem 4		Select the Arb Waveform stored in the non-Volatile Memory. The default location is: C:\ARB4:ARB_4

Figure 2-29(2) Table 2-15(2) Edit Stored Waveform Menu



Function Menu	Settings	Explanation
Edit Arb		Edit the selected waveform

3. To Delete a Waveform

Press **Arb** → **Edit Wform** → **DELETE Wform**, to delete a waveform.

To Generate the Modulated Waveform

Use the **Mod** button to generate modulated waveform. DG3000 Series can generate AM, FM, FSK, PM and PWM modulated waveforms. Modulating parameters vary by the types of the modulation. In AM, users can set the Source (Internal/ External), depth, Modulating Frequency, Modulating Waveform and Carrier Waveform; in FM, users can set the Source (Internal/ External), Frequency Deviation, Modulating Waveform and Carrier Waveform; in FSK, users can set the Source (Internal/ External), Frequency Range, Internal Rate, Modulating Waveform and Carrier Waveform; while in PM, users can set the Source (Internal/ External), Phase Deviation, Modulating Frequency, Modulating Waveform and Carrier Waveform, etc.

We will cover how to set these parameters in details by the types of the Modulation.

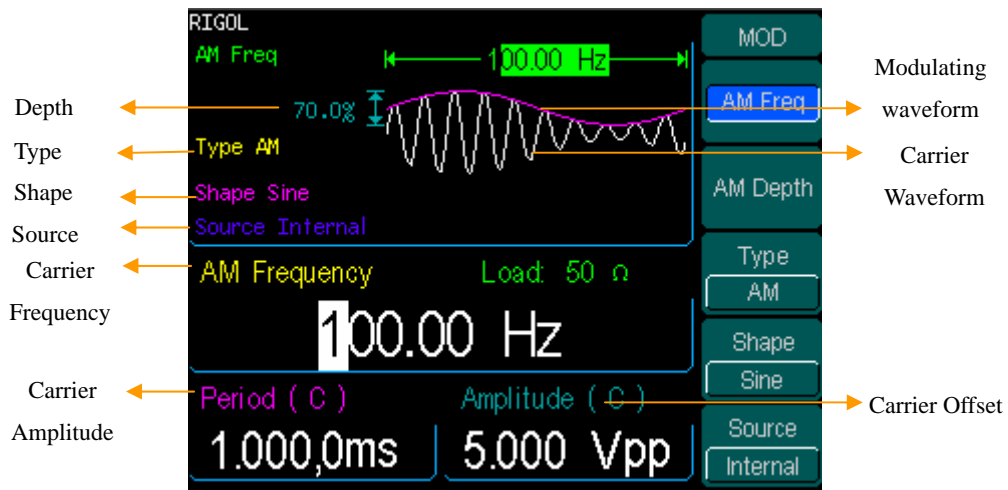



Figure 2-30
Modulated Waveform Parameter Interface

AM

The modulated waveform consists of two parts: the Carrier Waveform and the Modulating Waveform. In AM, the Amplitude of the Carrier Waveform varies with the instantaneous voltage of the modulating waveform. The Parameters for the AM are in Table 2-16.

Press **Mod** → **Type** → **AM**, to enter the following interface.

Figure 2-31 Table 2-16 Setting the AM parameters



Function Menu	Settings	Explanation
AM Freq		Set the modulating waveform frequency. Frequency Range: 2mHz~20kHz (Internal Source Only) .
AM Depth		Set the amplitude range
Type	AM	Amplitude Modulation
Shape	Sine Square Triangle UpRampD nRampNo ise Arb	Choose the modulating Waveform. To change the Carrier Waveform parameter, press Sine , Square etc.
Source	Internal	The Source is Internal
	External	The Source is External. Use the [Modulation In] connector in the Rear panel.

Term Explanation

Modulation Depth

The Amplitude Range (also called 'Percentage Modulation'). Modulation Depth varies from 1% to 120%.

- ✧ In the 0% Modulation, the output amplitude is the half of the set one.
- ✧ In the 100% Modulation, the output amplitude is the same with the set one.
- ✧ When the modulation is greater than 100%, the instrument output no greater than 10 Vpp. For an external source, the depth of AM is controlled by the voltage level of the connector connected to the [Modulation In]. +5V corresponds to the currently set depth.

FM

The modulated waveform consists of two parts: the Carrier Waveform and the Modulating Waveform. In FM, the Frequency of the Carrier Waveform varies with the instantaneous voltage of the modulating waveform. The Parameters for the FM are as shown in Figure 2-32.

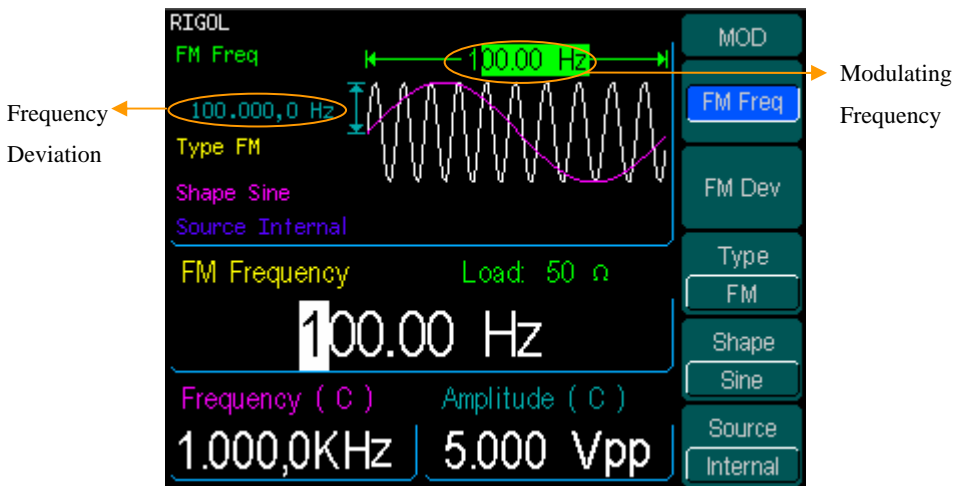

Figure 2-32

FM Waveform Parameter Setting Interface

Press **Mod** → **Type** → **FM**, to enter the following interface.

Figure 2-33

Table 2-17 Setting the FM parameters



Function Menu	Settings	Explanation
FM Freq		Set the modulating waveform frequency. Frequency Range: 2mHZ~20kHz (Internal Source Only) .
FM Dev		Set the Frequency Deviation between the Modulating Waveform and the Carrier Waveform
Type	FM	Frequency Modulation

Term Explanation

Frequency Deviation

- ✧ The Deviation should be equal to or less than the Carrier Waveform Frequency.
- ✧ The Sum of the Deviation and the Carrier Frequency should be equal to or less than maximum frequency of the selected function plus 100 kHz.
- ✧ For an External Source, the Deviation is controlled by the $\pm 5V$ voltage Level of the Connector connected to the [Modulation In]. +5V corresponds to the selected Deviation and -5V to the negative selected Deviation.

FSK

The FSK Modulation is a modulation method, the output frequency of which switches between two the pre-set frequencies (Carrier Waveform Frequency and the Hop Frequency). The Frequency for the Output Frequency to switch from the carrier waveform frequency to and from the Hop frequency is called the FSK rate. The frequency by which the output frequency switch from each other is determined by the Internal Frequency generator or the Signal Voltage Level offered by the **Trig In** connector in the rear panel:

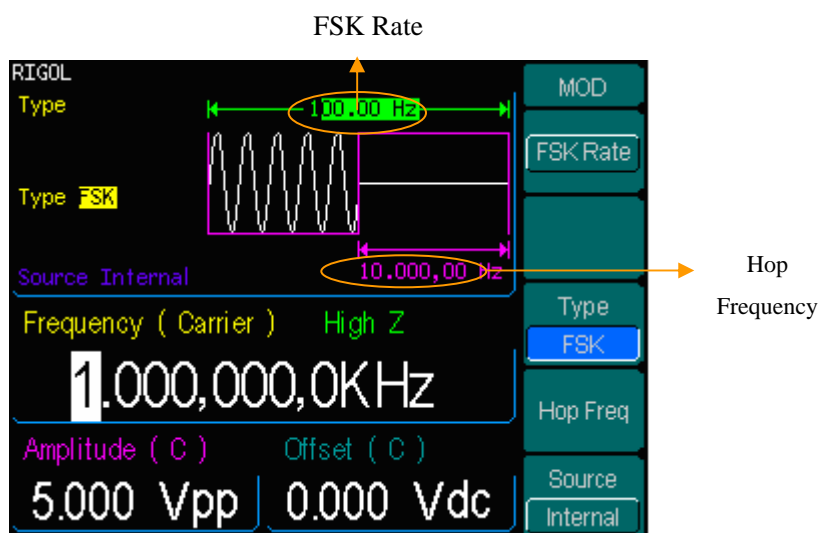

Figure 2-34
FSK Waveform Parameter Setting Interface

Press **Mod** → **Type** → **FSK**, to enter the following interface.

Figure 2-35 Table 2-18 Set FSK Parameters

MOD			
FSKRate			
Type			
FSK			
Hop Freq			
Source			
Internal			

Function Menu	Settings	Explanation
FSK Rate		Set the frequency at which the output frequency shifts between the carrier frequency and the Hop frequency (Internal Modulation Only): 2mHZ~1 MHz
Type	FSK	Frequency Shift Keying Modulation
Hop Freq		Set the Hop Frequency

PM

The modulated waveform consists of two parts: the Carrier Waveform and the Modulating Waveform. In PM, the Phase of the Carrier Waveform varies with the instantaneous voltage Level of the modulating waveform. The Parameters for the PM are as shown in Figure 2-36.

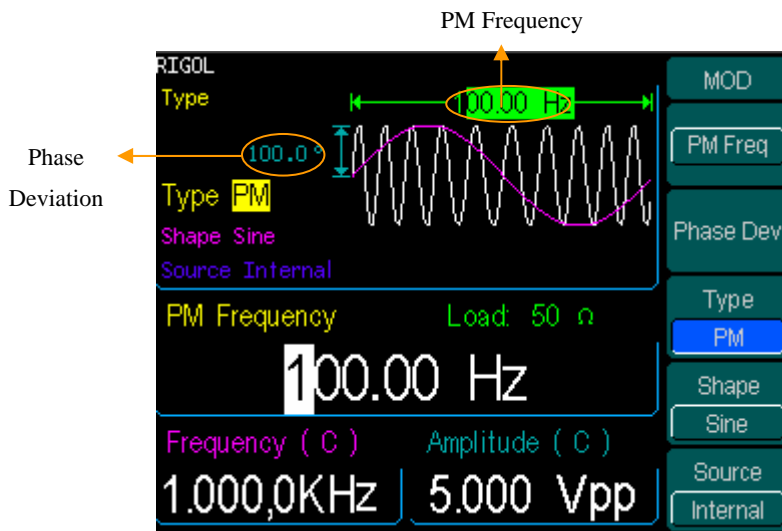
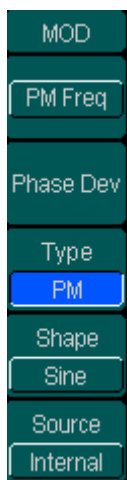

Figure 2-36

PM Waveform Parameter Setting Interface

Press **Mod** → **Type** → **PM**, enter the following interface.

Figure 2-37 Table 2-19 Setting the PM parameters



Function Menu	Settings	Explanation
PM Freq		Set the modulating waveform frequency. Frequency Range: 2mHz~20kHz (Internal source Only) .
Phase Dev		Set the Phase Deviation between the Modulating Waveform and the Carrier Waveform, ranging from 0° to 360°
Type	PM	Phase Modulation

PWM

The modulated waveform consists of two parts: the Carrier Waveform and the Modulating Waveform. In PWM, the width of the Carrier Waveform (Pulse) varies with the instantaneous voltage of the modulating waveform. The parameters for PWM are as shown in Figure 2-38.

PWM can only be used for pulse modulation, press **Mod**, enter the modulation interface you may discover that the function key **PWM** is cryptic when you choose the modulation type, but it will appear when you press **Mod** in the **Pulse** interface.

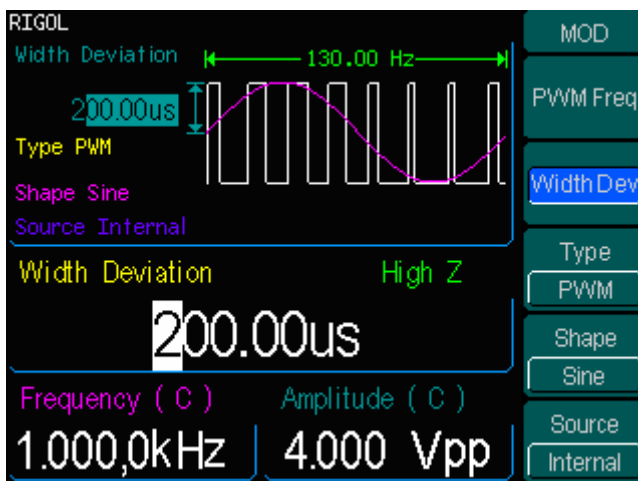

Figure 2-38
PWM Waveform Parameter Setting Interface

Press **Pulse** → **Mod**, enter the following menu.

Figure 2-39

table 2-20 Setting the PWM parameters



Function Menu	Settings	Explanation
FM Freq		Set the modulating waveform frequency. Frequency Range:2mHz ~ 20kHz (only for internal source) .
Width Dev		The setting range :0~200us
Source	Internal	Choose the internal source.
	External	Choose the external source, use the linker [Modulation In] in the rear panel.

Note:

The maximum of the (duty deviation)/(width deviation) is the smaller one in [(pulse duty/width), 1-pulse width].

To Generate Sweep

In the frequency sweep mode, the function generator “steps” from the start frequency to the stop frequency at the sweep rate you specify. Sweep can be generated by Sine, Square, Ramp or Arbitrary Waveforms (Pulse, Noise and DC are not allowed).

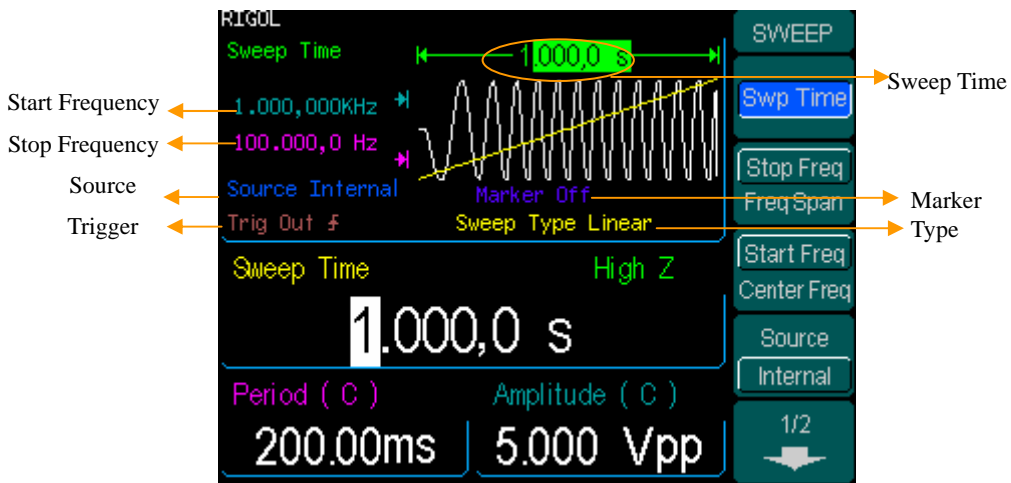

Figure 2-40

Sweep Waveform Parameter Setting Interface

Press **Sweep** button to enter the following menu. Set the Waveform parameters by using the operation menu.

Figure 2-41 (1) Table 2-21(1) Waveform Sweep Setup



Function Menu	Settings	Explanation
Swp Time		Set the Time Span of the Sweep for which the Frequency changes from the Start Frequency to Stop Frequency.
Stop Freq Freq Span		Set the Stop Frequency of the Sweep Set the Frequency Span of the Sweep
Start Freq Center Freq		Set the Start Frequency of the Sweep Set the Center Frequency of the Sweep
Source	Internal External Mannal	Choose Internal Source Choose External Source, use the [Modulation In] connector in the rear panel Choose External Source, set the start and stop time by hand

Sweep Frequency Setting

Use **Start Freq** and **Stop Freq** or **Center Freq** and **Freq Span** to set the range of the frequency. Press the button again to switch between each other.

- To Sweep upward, set the Start Frequency lower than the Stop Frequency, or set a positive frequency interval.
- To Sweep downward, set the Start Frequency higher than the Stop Frequency, or set a negative frequency interval.

Figure 2-41(2) Table 2-21(2) Waveform Sweep parameter setting



Function Menu	Settings	Explanation
Trig		Signal Triggered at Rise Edge
		Signal Triggered at Fall Edge
	Off	Turn off Trigger Setting
Marker	Freq	Choose the Marker Frequency
	Off	Turn Off the Marker Frequency
Linear Log	/	Set the Sweep with linear spacing
		Set the Sweep with logarithmic spacing

Mark On/Off

Choose the Mark Frequency, and the frequency of the Signal on the [Sync] Connector will change according to this frequency. The Output of the [Sync] Connector will turn High at the start of the Sweep. If you close the Mark, the synchronous signal will turn Low at the center of the Sweep; otherwise, the synchronous signal turns Low when the frequency reaches the specific mark. The Mark Frequency should be between the Start Frequency and the Stop Frequency.

If the synchronous signal is disabled, then disable Mark Signal.

To Generate Burst

Burst Function can generate versatile waveforms in burst, which can last specific times of waveform cycle(N-Cycle Burst), or when external gated signals(Gated Burst) is applied, any waveform could be used, But noise can only be used in Gated Burst.

Press **Burst** button to enter the following interface. Set the Waveform parameters by using the operation menu.

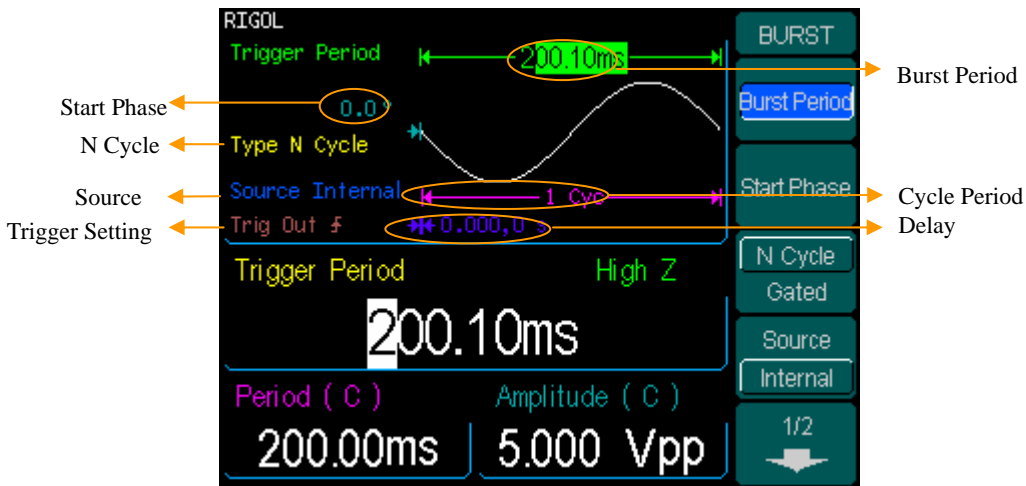



Figure 2-42
Burst Waveform Parameter Setting Interface

Set the N-Cycle Burst

Press **Burst** → **N Cycle**, to enter the following interface.

Figure 2-43(1) Table 2-22(1) Setting the N-Cycle parameters

	Function Menu	Settings	Explanation
	Burst Period		Set the Burst Period
	Start Phase		Set the Start Phase of the Burst
	N Cycle Gated		Use the N-Cycle Mode Use the Gated Mode
	Source	Internal External Manual	Choose Internal Source Choose External Source, use the [Modulation In] connector in the rear panel Choose External Source, set the start and stop time by hand

Burst Period

Set the time span between an N-Cycle Burst to the next. If necessary the period will increase to allow the specific number of cycles in a burst.

Burst Period> Period X Burst Number

Start Phase



Define the Start and the Stop Point in a waveform. The phase varies from -360° to $+360^\circ$, and the default setting is 0° . For an Arbitrary Waveform, 0° is the first waveform point.

N-Cycle/ Gated

N-Cycle has specific number of waveform cycles, and every burst is activated by a trigger event. Gated burst use external source to control burst as when to be activated.

Figure 2-43(2) Table 2-22(2) N Cycle Burst Setting



Function Menu	Settings	Explanation
Trig	  Off	Signal Triggered at Rise Edge Signal Triggered at Fall Edge Turn off Trigger Setting
#Cycle	/	Set the Number of the bursts in a N-Cycle
Infinite		Set the Number of the bursts in a N-Cycle to be infinite
Delay	/	Set the Delay time before the burst starts

Cycle

Set the number of Waveform Cycle in an N-Cycle (1 to 500,000 or Infinite).

If you choose Infinite, then a continuous waveform will be generate which will not stop until a trigger event happens (Trigger button is pressed).

- If needed, Burst Period will increase to cater to the specific number of cycles.
- For a frequency greater than 25M Hz, only a burst with infinite cycles is allowed.
- For an infinite-cycle Burst, External or Manual Trigger is needed to activate burst.

Delay

Set the Time Delay between the Trigger Input and the Start of the N-Cycle Burst. The minimum delay is a function of the specific burst period, and should always be greater than 0.

Set the Gated Burst

Press **Burst** → **Gated**, to enter the following interface.

Figure 2-44



Table 2-23 Setting the Gated parameters

Function Menu	Settings	Explanation
Start Phase		Set the Start Phase for the Gated Signal
N Cycle Gated		Set the Gated Mode
Polarity	Positive Negative	Set the Polarity for the Gated Signal

To Store and Recall

Press **Store/Recall** Button to enter the following interface. You can save or recall the State or Data Documentation inside the Generator. The status file and data file on the U Disk are also allowed to rebuild or delete. File names can either be Chinese or English.

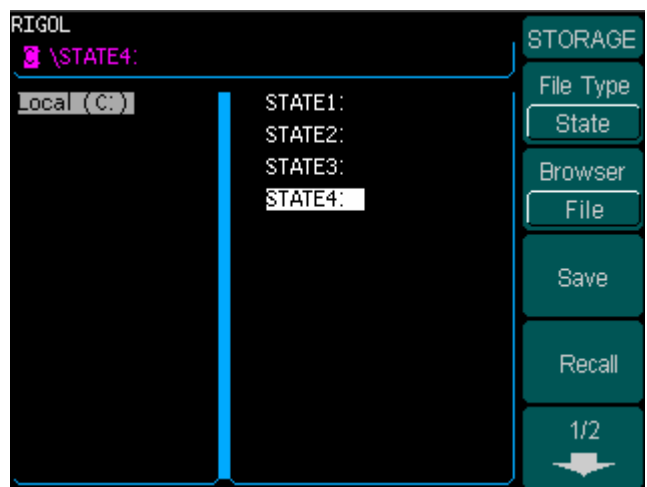

Figure 2-45
Save and Read Interface

Figure 2-46(1)

Table 2-24(1) Save and Recall Menu



Function Menu	Settings	Explanation
File Type	State Data All File	The Setting of the Generator Arbitrary Waveform file All kinds of files
Browser	Path Directory File	Shift between the Path, Directory and file
Save		Save the waveform to the appointed place(See Table 2-25
Recall		Recall the waveform or Setting information in the specific position in the memory.

Figure 2-46(2) Table 2-24(2) Save and Recall Menu



Function Menu	Settings	Explanation
Delete		Delete the selected file

About the browser

The directory selection shift is done by the direction keys. In the directory mode, pressing the right key will open the lower directory while the left key will fold the directory. Up and Down key are used to shift between the directories; in the Path mode, right key stands for the lower directory, left key upper, up key route, and down key the lowest or the stroll bar between the files.

To Save the Instrument State

Users are allowed to store the instrument state in any of the 4 Non-Volatile Memories. The state storage will “memorize” the selected function (including the Arbitrary Waveform), Frequency, Amplitude, DC Offset, Duty Cycle, Symmetry, and other modulation parameter used.

To Save the Instrument State, the procedures are as follows:

- (1). Choose the file Type to store
Press **Store/Recall** → **Type** → **State**, and choose State as the storage type.
- (2). Choose the location of the file.
There are four positions in the Local(C :) STATE1, STATE2, STATE3 and STATE4, choose anyone of them by rotating the knob.
- (3). Name the file and Save it
Press **Save** button, enter the desired name. Press **End/Store** to finish.

To Save Data

Users are allowed to store data document on any of the 4 Non-Volatile Memories. If the place is already occupied, new document will cover the old one. The procedure for data storage is as follows:

- (1). Choose the file Type to store

Press **Store/Recall** → **Type** → **data**, and choose data as the storage type.

- (2). Choose the location of the file.

There are four positions in the Local(C :) ARB1, ARB2, ARB3 and ARB4, choose anyone of them by rotating the knob.

- (3). Name the file and Save

Press **Save** button, enter the desired name. Press **End/Store** to finish.

The Seamless Interaction of DG3000 and DS1000

Above we have introduced to you the interfaces of DG3000, and mentioned the USB Host Interface. Below, we will introduce to you how to use this interface to connect DG3000 and DS1000 to realize the nondestructive data Transmission.

Step one, Connect DG3000 with DS1000, and acquire data.

Step two, Connect the USB Host Interface of DG3000 with the USB Device Interface of DS1000. View the waveform acquired. The procedures are as follows:

View the Acquired Waveform

Press **Store/Recall** Button, to enter the following menu.

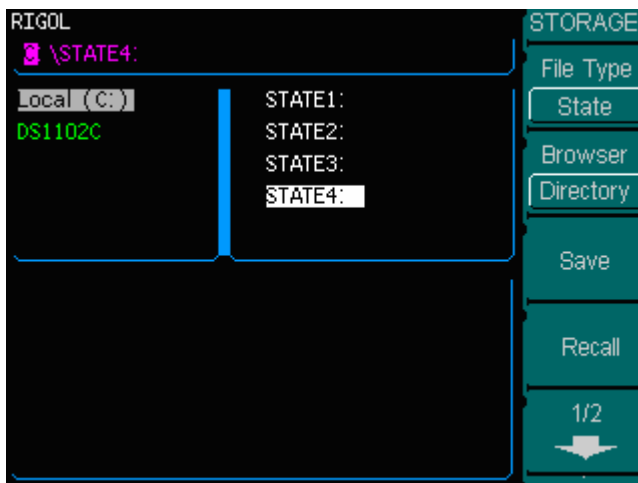

Figure 2-47
The operation menu

Press **Browser** → **Directory**, use the knob to select DS1102C and make it be displayed in inverse color.

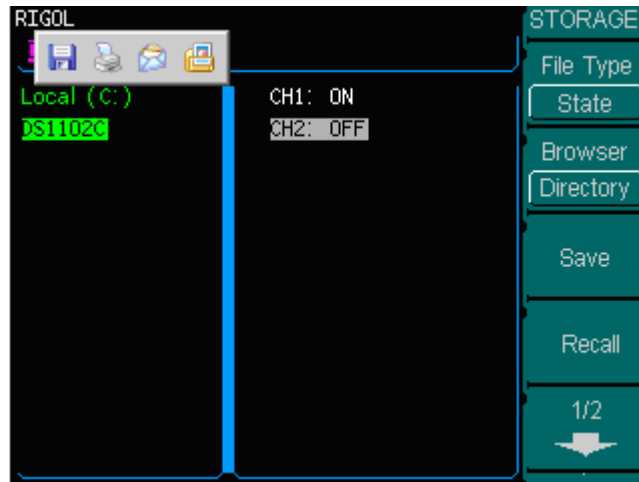

Figure 2-48
Choose the directory

Press **Browser** → **File**, use the direction key to choose **CH1: ON** and make it be displayed in inverse color (choose the channel that you want to recall the information).

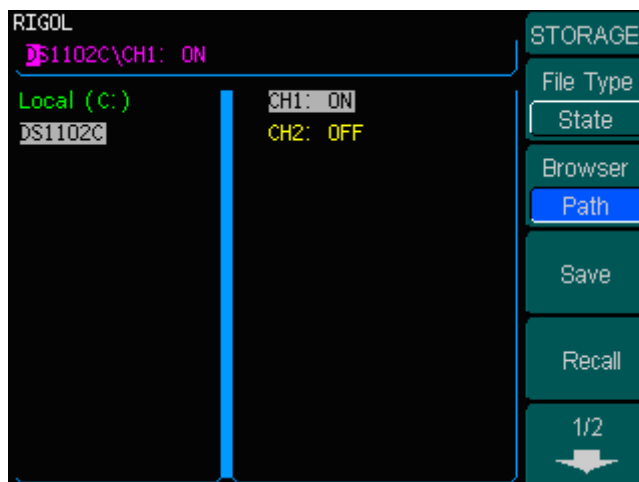

Figure 2-49
Choose the channel

When the preparation is done, the following steps will help you read the information DS1000 acquired.

RIGOL

Press **Recall** and DG3000 will recall the waveform data acquired by DS1000 into the Volatile Memory.

Note: when recalling, DG3000 will recall once and write once, so there will be 2 processing bar. If there is only one shown, it means that the recall operation is unsuccessful.

To generate the waveform acquired

Press **Arb** → **Sel Wform** → **Volatile Wform**, to load the waveform just recalled.

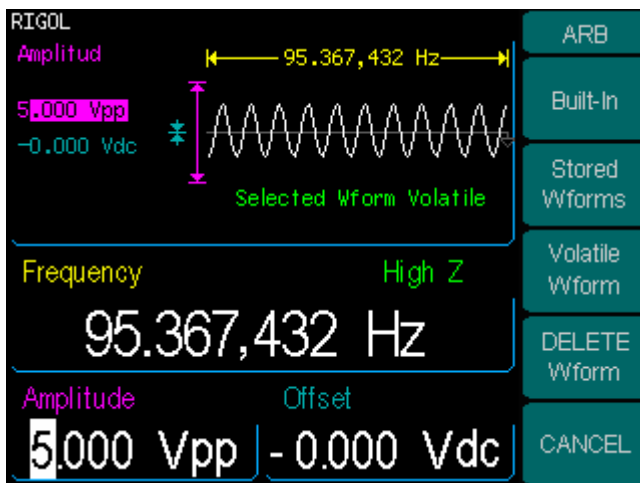

Figure 2-50

Load the waveform

Notes: The frequency shown on DG3000 may vary greatly from what you imagine. This is because that DG3000 consider the 512K points acquired as a period. If you want to get the real period of the generated waveform, you have to use the frequency value shown on DG3000 times the number of the real period in this false period.

As shown in the figure below, this is the waveform shown on another DS1000 using the above operation. Please note that the frequency shown on this instrument is the same as the precious one.

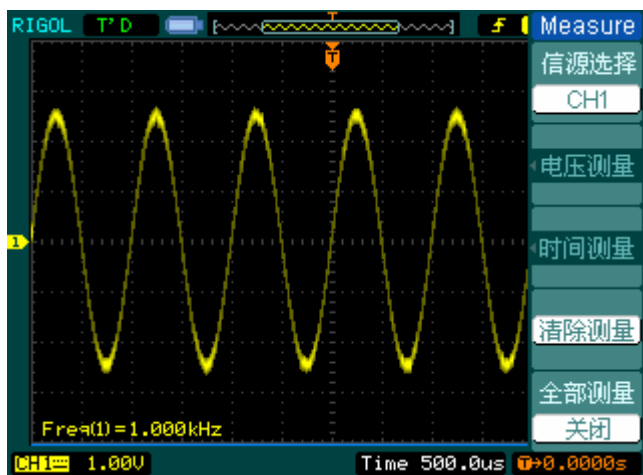

Figure 2-51

The Reappearance waveform

TO save the data in the Volatile memory into the Non-Volatile Memory

The information in the Volatile Memory will disappear once the instrument is powered off. To save the valuable information, save the information to the Non-Volatile Memory.

First edit the Arbitrary Waveform in the Arb function and press **Arb** → **Edit Wform** ,

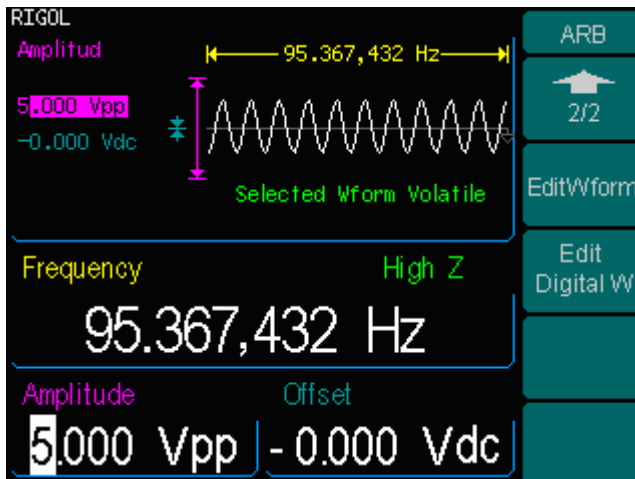

Figure 2-52

Edit the waveform

Figure 2-53 Figure 2-54(1)

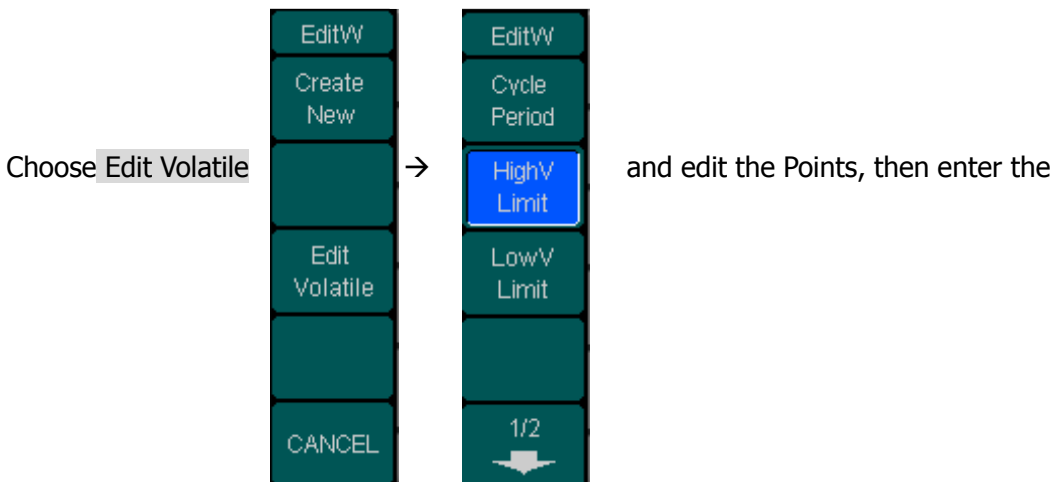
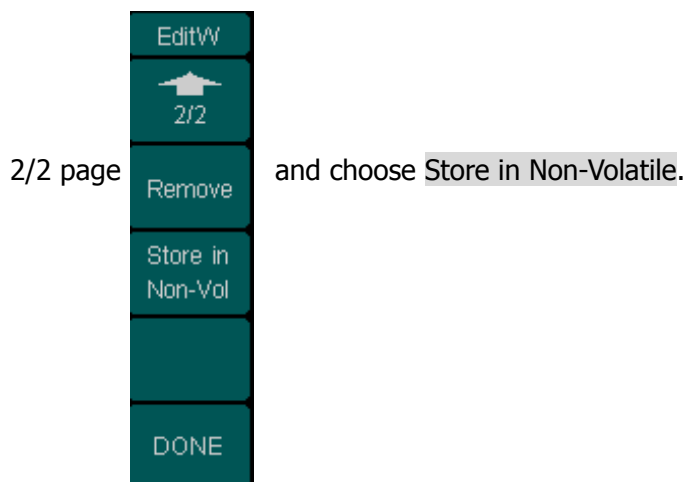

Figure 2-54(2)



Press **Store/Recall**, choose the location, to finish the operation.



Figure 2-55

Choose the location

To Use USB storage

As is shown in figure 2-56, the storage location is divided into: The internal Storage Local(C :) and the U Disk storage U Disk (A :). At the left side of the front panel, there is a USB interface. When a USB storage is connected, the storage menu will show "Mobile Disk (A:)". Otherwise, the default location is the internal location Local(C :).

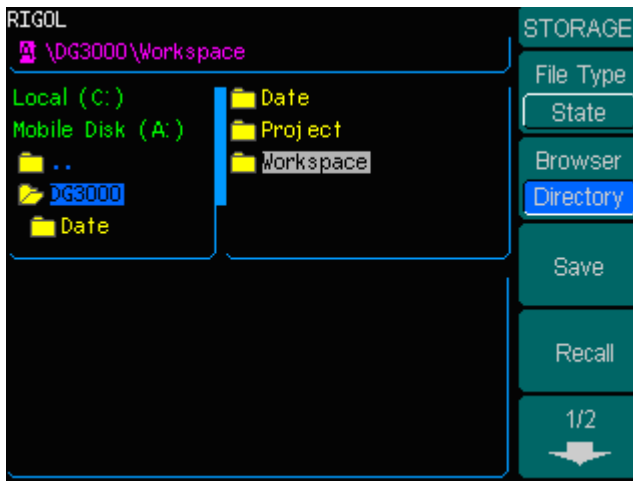

Figure 2-56
To use the USB Storage

- (1). Install the Mobile Disk
Insert the Mobile Disk into the USB interface on the front panel, and the screen will show "Detect a Mobile Disk", and storage menu will show "Mobile Disk (A:)"
- (2). Choose the Mobile Disk
Press **Browser** → **Directory**, move the cursor with the up or down direction key to select "Mobile Disk (A:)". Press the right key to open the lower directory, use the up and down direction key to choose the file " DG3000". Use the right key to open the lower directory, and up and down key to select the file "Workspace". Input the file name and save.
- (3). Remove the Mobile Disk
Remove the Mobile Disk from the Interface. The system will inform you "The Mobile Disk is removed", and the "Mobile Disk (A:)" in the storage menu will disappear.

Note: Mobile Disk can only be U Disk; portable hard disk is not supported.

To Save a File

Press **Store/Recall** → **Store**, to enter the following interface. Enter the desired file name in the "File Name" frame. In the middle of the figure below is the input keypad, used to edit the file name. Use the up and down direction keys and knob to select the desired character; use the left and right direction keys to edit the input file name.

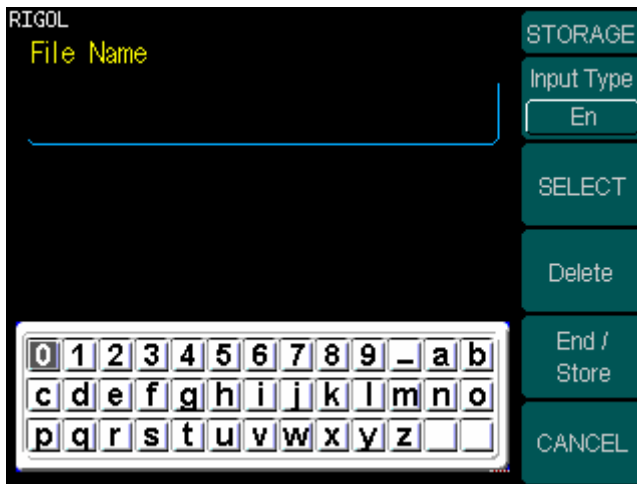

Figure 2-57
File Storage Interface

Figure 2-58



Table 2-25 File Storage Menu

Function Menu	Settings	Explanation
Input Type	En Chn(s)	English Input Chinese Input
SELECT		Select the current character
Delete		Delete the current character
End/Store		Store the file with the current name

1. English Input

The English Input Interface is as shown in Figure 2-59, to save a file named "NewFile", follow the steps below:



Figure 2-59
English Input Interface

- (1). Press **Input Type** → **En**, to enter the English Interface.
- (2). Input the file name "NewFile".
Use the Knob to adjust the cursor's horizontal position and the up and down key to adjust the vertical position. Select the Character "N" and press **Select**. Repeat this until you have inputted "NEWFile". Press the **+/-** button on the number Keypad to shift into the Capitalized Input mode
- (3). Edit the File Name
When you have entered a wrong character, move the cursor to the wrong character to be deleted and press **Delete** to remove it. Reenter the file name.
- (4). Press **End/Store**, to finish and save the file.

2. Chinese Input

The Chinese Input Interface is as shown in figure 2-60. To save a new file named “信号发生器”, follow the instructions below:

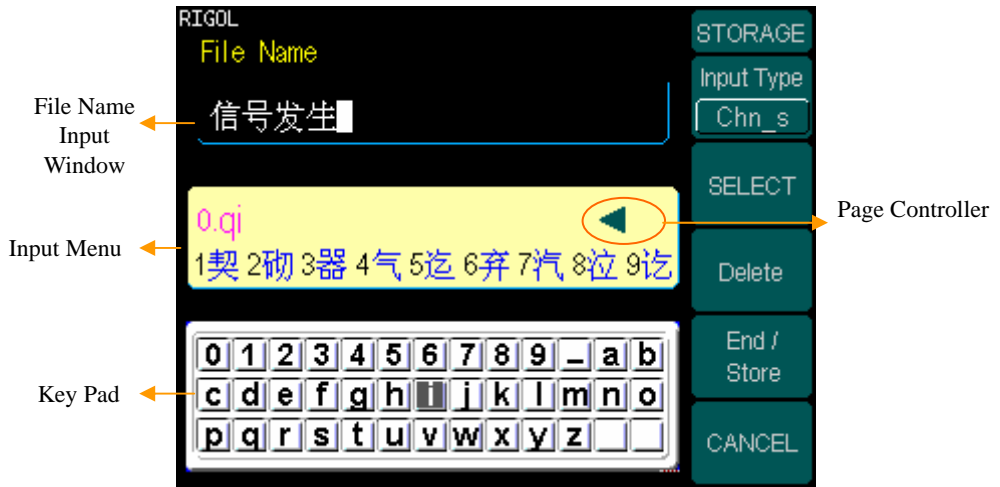

Figure 2-60

Chinese Input Interface

- (1). Press **Input Type** → **Chn(s)**, to enter the Chinese Input Interface.
- (2). Press the “+/-” button on the Number Keypad, to shift Capitalization, and choose the input to be Minuscule and enter Chinese.
- (3). Input the file name : “信号发发生器”
Use the Knob to adjust the cursor’s horizontal position and the up and down key to adjust the vertical position. Select the Character “q” and press **Select**. Repeat till all the needed characters are selected. In the Input Menu, choose the Chinese character you need with the help of the page controller and the 1~9 button on the keypad.
- (4). Edit the wrongly input
When a file name is wrong, move the cursor to the character to remove and press **Delete** to remove it and reenter the file name.
- (5). Press **End/Store** , to finish and save the file.

To Set the Utility Function

With the **Utility** Function, you can set the parameters of the Generator such as: DC On/Off, Sync On/Off, Output Parameter, Interface Parameter, System Setting and Testing Parameter. The DC switch offers the options of DC output or Arbitrary Waveform Output. Sync Switch offers the option to choose the Sync Signal or not. Output Setting provides the parameter setting for Load/Impedance, Range, Normal/Inverse and Phase. Interface Setting offers the storage and load of the configure parameter setting for GPIB (IEEE-488), LAN, RS232 or USB remove Control. The System Setting provides the setting for Language, Display, Beep, Screen Guard, Format, Power System Configure and default setting; Test provides the self-testing and calibration storage.

Press **Utility** button, to enter the Utility Menu. Its functions are listed below in table 2-26.

Figure 2-61(1) Table 2-26(1) Utility System Setting

UTILITY			
DC			
Off			
Sync			
On			
Output Setup			
I/O Setup			
1/2			
↓			
Function Menu	Settings	Explanation	
DC	On Off	Set the output waveform to be DC Set the output waveform to be Arbitrary.	
Sync	On Off	Activate the Sync Signal on the [Sync] Connector on the front panel. Deactivate the Sync Signal on the [Sync] Connector on the front panel.	
Output Setup	/	Set the Output parameter	
I/O Setup	/	Set the I/O	

Figure 2-61(2) Table 2-26(2) Utility System Setting

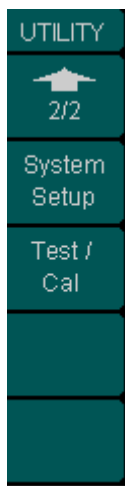

Function Menu	Settings	Explanation
System Setup	/	Set the System Configuration
Test/ Cal	/	Test and Calibrate the instrument

Instruction

Sync Switch Setting:

When the amplitude is relatively low, disabling Sync Signal can reduce the distortion in output. The current choice is stored in Non-Volatile Memory. If the Sync Signal is already disabled, then the Mark Signal in the Sweep Mode should also be disabled.

To Set the DC Output

Press **Utility** → **DC** → **On**, to enter the following interface. Please note that there is a "DC ON" sign at the top left of the screen.

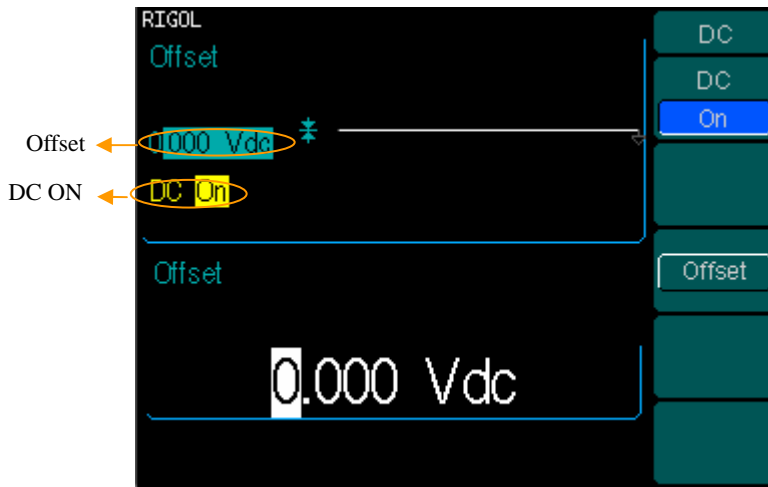

Figure 2-62
DC Setting Interface

DC Offset

Set the DC Voltage Level.

To Shift into the Arbitrary Waveform Output

- (1). Press **Utility** → **DC** → **DC Off**, to close DC Output and return to Arbitrary Waveform output.
- (2). Press any functional button, and the waveform output setting turns into the arbitrary waveform output. The DC option is turned off automatically.

To Set the Sync Output

The Generator provides Sync output through the [Sync] Connector on the Front Panel. All standard output functions (except DC and Noise) have a corresponding Sync Signal. For some Sync applications, they can be disabled if users do not want to use them,

- In the default setting, the Sync Signal should be connected to the [Sync] Connector (activated). When the Sync Signal is disabled, the output Voltage of the [Sync] Connector is Level Low.
- In the Inverse Mode, the Waveform that corresponds to the Sync Signal does not Inverse.
- The Setting of Mark Signal in the Sweep Mode will deactivate the Sync Signal. Thus, when the Mark Frequency is enabled (Sweep Mode activated), the Sync Signal Setting will be overlooked.
- For Sine, Square and Pulse Signal, the Sync Signal is a Square Signal with 50% Duty Cycle. When the output is positive, The Sync Signal is TTL Level High compared to 0 V Voltage or DC Offset; when the output is negative, The Sync Signal is TTL Level Low compared to 0 V Voltage or DC Offset.
- For Square Waves, the Sync Signal is a Square Wave with the same Duty Cycle with the main output Square Wave. When the Output is positive, The Sync Signal is TTL Level High compared to 0 V Voltage or DC Offset; when the output is negative, The Sync Signal is TTL Level Low compared to 0 V Voltage or DC Offset.
- For Arbitrary Waveform, the Sync Signal is a Square Waveform with 50% Duty Cycle. At the time when the first output waveform point is generated, the Sync Signal Voltage is TTL Level High.
- For Internal Modulating AM, FM and PM, the Sync Signal reference is the Modulated Signal (not the Carrier Signal). The Sync Signal is a Square Waveform with 50% Duty Cycle. In the first half modulation period, the Sync Signal is TTL Level High. For External Modulation, the Sync Signal reference is the Carrier Signal (not the Modulated Signal). The Sync Signal is also a Square Waveform with 50% Duty Cycle
- For FSK, the Sync Signal Reference is the Hop Frequency, and the Sync Signal is a Square Waveform with 50% Duty Cycle. For the Hop Frequency, at the hopping point, the Sync Signal is TTL Level High.
- For a Sweep which disables the Mark function, the Sync Signal is a Square Waveform with 50% Duty Cycle. When the Sweep starts, the Sync Signal is TTL Level High and turns Low at the Center of the Sweep. The Sync Frequency equals

the specific Sweep time. For a Sweep that enables the Mark Function, the Sync Signal is TTL Level High at the beginning of the Sweep and turns Low at the Mark Frequency.

- For the Burst, when the burst starts, the Sync Signal is Level High. At the specific point when the Cycle Number ends, the Sync Signal turns Level Low (If the Waveform has a relative starting phase, then intersections may occur). For an infinite burst, the Sync Signal is the same with the Sync Signal of the continuous Signal.
- For the External Gated Burst, the Sync Signal follows the External Gated Signal. But, please note that this signal will not turn Level Low until the end of the last period (If the Waveform has a relative starting phase, then intersections may occur).

To Set Output Parameter

Press **Utility** → **Output Setup**, to enter the following interface.

Figure 2-63

Table 2-27 Output Set Menu



Function Menu	Settings	Explanation
Load		Set the Load connected to the Output Connector.
High Z		Set the Load connected to the Output Connector to be High_Z.
Range	Auto	Allow the Instrument to choose the best Amplifier/ Attenuator
	Hold	Disable the Auto Adjusting
Normal Invert		Normal Output
		Inverse Output
Adjust Phase		Set the Phase Offset of the Output Waveform

Instruction

Hold Range

Select **Hold**, to disable Auto adjusting. This will eliminate the "Jitter" caused by the switch of the Attenuator. But, the precision and the resolution (the fidelity of the original waveform) may be affected.

1. To Set the Output Load

For the [Output] Connector on the Front panel, the Generator has a built-in 50Ω series impedance. If the actual load does not match the set one, the displayed amplitude and offset are incorrect. This function is used to match the displayed voltage with the expected one.

Steps for setting the Load:

- (1). Press **Utility** → **Output Setup** → **Load**, to enter the following interface.

Please note that the Load Parameter shown on the right bottom is the default setting when the power is on or the pre-set load value. If the current value is valid for the output, then is current value will be used.

- (2). Input the desired Load Value.

Use the Keypad or the Knob to enter the desired value and choose the unit, Ω or $K\Omega$, press the corresponding button.

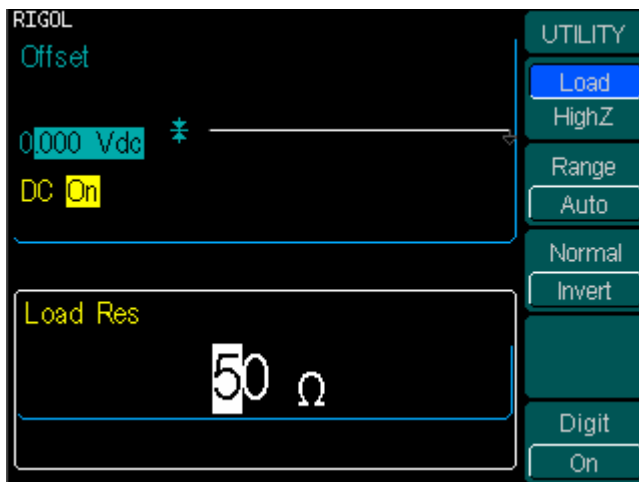

Figure 2-64
Set the Output Load

Instruction

DG3000Series has a fixed 50Ω Series Impedence. No matter what Value the set parameter is, if the real load is different from the set one, the displayed voltage will not equal the real voltage.

2. To Set the Invert Waveform

Press **Utility** → **Output Setup** → **Invert**, to set the Inverse Waveform Output. When the waveform is Inverse, no offset will change. An inverse waveform will be displayed in the Graph Mode.

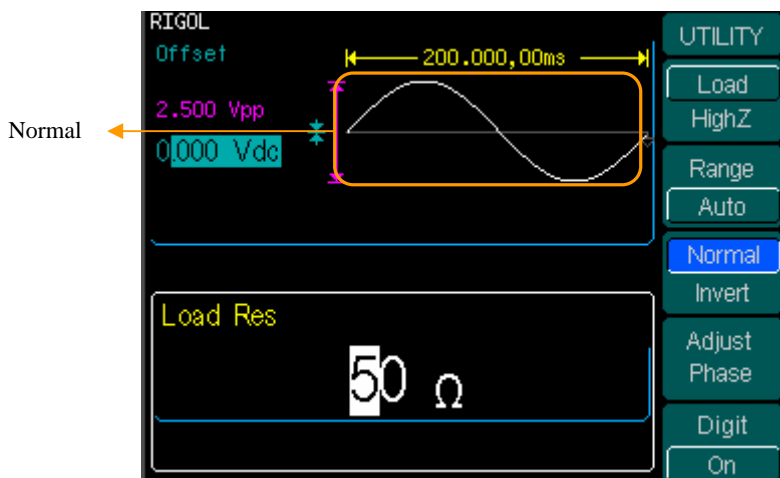

Figure 2-65
Normal Waveform

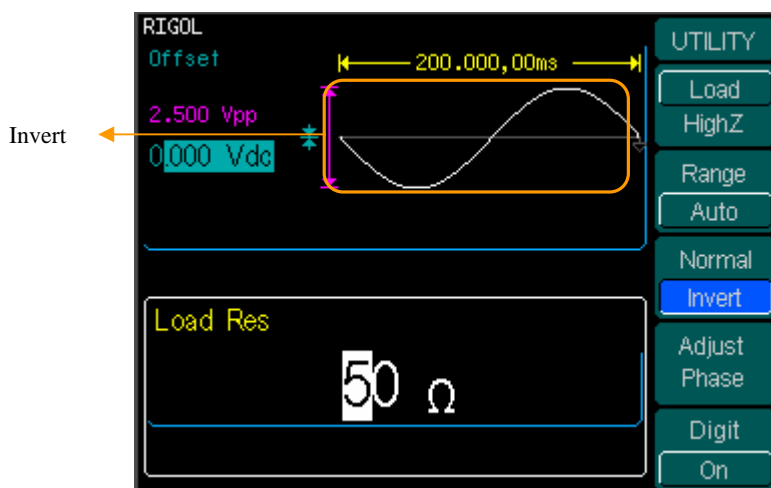

Figure 2-66
Inverse Waveform

3. To Adjust the Phase

Press **Utility** → **Output Setup** → **Adjust Phase**, to enter the following interface

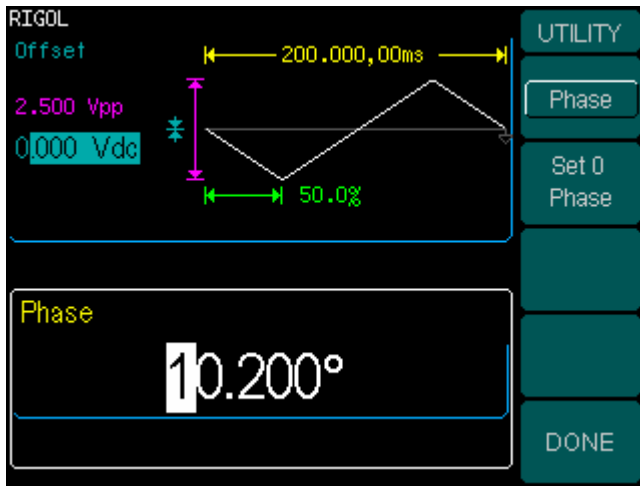

Figure 2-67
Set the Phase

Figure 2-68

Table 2-28 Phase Adjust Menu



Function Menu	Settings	Explanation
Phase		Set the Output Phase by degree.
Set 0 Phase		Reset the phase to 0.

To Set the I/O

Press **Utility** → **I/O Setup**, to set the I/O.

Figure 2-69

UTILITY
GPIB Address
LAN
Show USB Id
RS232
DONE

Table 2-29 I/O Setup Menu

Function Menu	Settings	Explanation
GPIB Address		Set the GPIB Address
LAN		Set the LAN configuration parameter
Show USB Id		
RS232		Set the RS232 Interface

Set the GPIB address any number between 0 and 30. The default setting is "1".the Address is stored in the Non-Volatile Memory, and will show when the power is on. The I/O Setting offers the Storage and Load of the configuration parameter setting of the GPIB (IEEE-488) , RS232 or LAN which are used for remote control. GPIB and RS232 can not be used together.

1. To set the LAN

Offer the Storage and Load Operation of the Network Configuration needed for Remote Control of LAN Interface. You can configure IP Address, DNS setting or check the current network configuration.

Press **Utility** → **I/O Setup** → **LAN**, to enter the following interface.

Figure 2-70

Table 2-30 LAN Setup Menu



Function Menu	Settings	Explanation
IP Setup		Set the corresponding parameter for IP
DNS Setup		Set the corresponding parameter for NDS
Current Config		The current setting information about the host

IP Setup

Press **Utility** → **I/O Setup** → **LAN** → **IP Setup**, to enter the following interface.

Figure 2-71

Table 2-31 IP Setup Menu



Function Menu	Settings	Explanation
DHCP	On	Open DHCP setting, allot IP address dynamically
	Off	Close DHCP setting, allot IP address manually
IP address		Set the IP address
Subnet Mask		Set the IP Mask
Default Gateway		Set the Gate Way

Instruction

Open DHCP:

Press **DHCP** → **On**, to allot the IP address dynamically. At this time, the **IP Address**, **Subnet Mask** and **Default Gateway** menu will hide.

DNS Setup

Press **Utility** → **I/O Setup** → **LAN** → **DNS Setup**, to enter the following interface.

Figure 2-72 Table 2-32 DNS Setup Interface



Function Menu	Settings	Explanation
Host Name		Set the Host Name
Domain Name		Set the Domain
DNS Server		Set the Server Address

Host Namer

Set the Host Name, consists of letter, number and dash (“-”). Consult to your network administrator for information if you need to provide the Host name and the name to use. Use the knob and direction button to select the character (you can only use the keypad to enter number). The Host name will be stored to the Non-Volatile Memory.

Domain Name

Set the Domain Name with letter, number, dash (-) and dot (.). Consult to your network administrator for information if you need to provide the Domain name and the name to use. Use the knob and direction button to select the character (you can only use the keypad to enter number). The Domain name will be stored to the Non-Volatile Memory.

Instruction

If the DHCP is enabled, and you want to use the DNS address DHCP Server returns, please set the Server to be “0.0.0.0”.

Current Config

Press **Utility** → **I/O Setup** → **LAN** → **Current Config**, to display the current LAN Setup information, as is shown below.

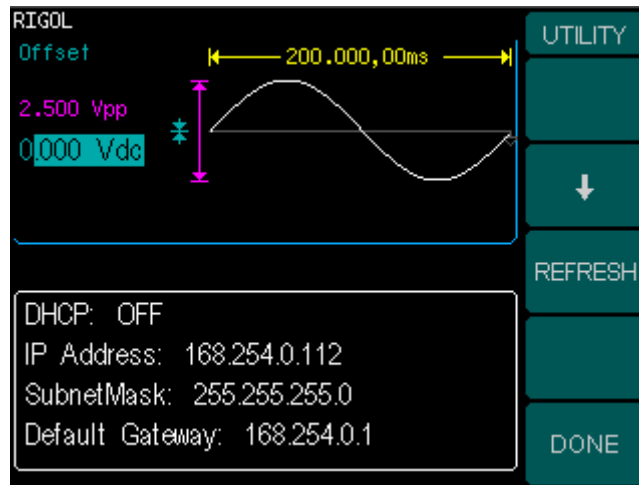

Figure 2-73
The current configuration information

2. RS232 Setting

Choose RS232 I/O. Make sure that the Baud Rate, Parity and Signal Exchange Setting matches that of the computer used. Besides, make sure that the RS232 cable used is connected correctly. I/O choice is stored in the Non-Volatile Memory, and will show when the power is on.

Press **Utility** → **I/O Setup** → **RS232**, to enter the following interface.

Figure 2-74 Table 2-33 RS232 Setup

UTILITY	Baud Rate	Parity / # Bits	DONE
---------	-----------	-----------------	------

Function Menu	Settings	Explanation
Baud Rate	/	Set the RS232 Baud Rate
Parity/ #Bits	/	Set the RS232 Parity and bit

Baud Rate

Set the RS232 Baud Rate. Make sure that the Baud Rate matches that of the computer. The optional rates are: 2400, 4800, 9600, 19200, 38400, 57600 and 115200. The default setting is 9600. Current choice is stored in the Non-Volatile Memory.

Parity/ #Bits

Set the Parity of RS232. Make sure that the parity matches that of the computer. The choices are: Odd/ 7 bits, Even/ 7 bits and No Parity/ 8 bits. The default setting is No Parity/ 8 data bits. Current choice is stored in the Non-Volatile Memory.

To Set the System

Press **Utility** → **System Setup**, to enter the following interface.

Figure 2-75(1) Table 2-34(2) System Setup Menu



Function Menu	Settings	Explanation
Number format		Set the number format
Language		Set the Display Language
Power On	Default	all the settings return to default when powered
	Last	all the settings return to the last one when powered
Set to Default		Set all the settings to default

Figure 2-75(2) Table 2-34(2) System Setup Menu



Function Menu	Settings	Explanation
Display Control		Set the parameter for the Screen Display
Beep	On	Open Beep
	Off	Close Beep
Scrn Svr	On	Activate the Screen Guard Program. Screen Guard will be on if no action is taken within 3 minutes. Press any button the resume.
	Off	deactivate the Screen Guard Program

Key points:

Power On

Choose the configuration setting when the machine is powered.

Two choices are available: the default setting and the latest. Once selected, the setting will be used when the instrument is powered.

Beep

Activate or deactivate the sound when an error occurs from the front panel or the remote interface. Activate or deactivate any sound made by the button or knob on the front panel. The current setting is stored in the Non-Volatile Memory.

1. Set the Format

Press **Utility** → **System Setup** → **Number Format**, to enter the following interface.

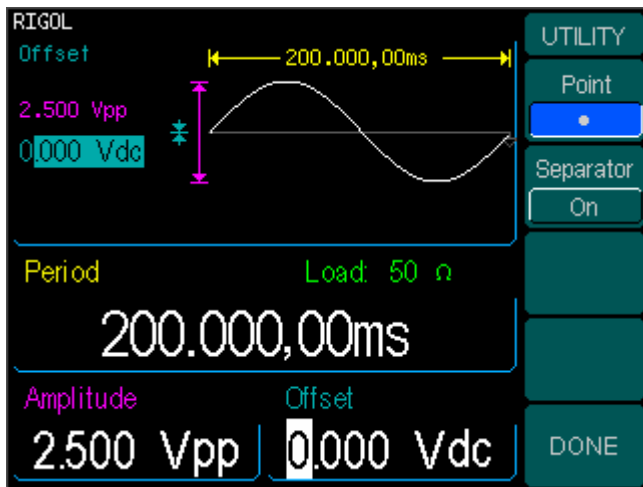

Figure 2-76

Set the number Format

Figure 2-77



Table 2-35 Set the Number Format

Function Menu	Settings	Explanation
Point	• ,	Using dot to represent point Using comma to represent point
Separator	On Off Space	Enable the Separate Close the Separate. Use Space to separate

According to the different choices of the point and the separator, the format can have various forms:

(1). • as point, press **Separator** → **On** , the example is as follows:



Figure 2-78 The set format

(2). ¢ as point, press **Separator** → **On** , the example is as follows:



Figure 2-79 The set format

(3). • as point, press **Separator** → **No** , the example is as follows:



Figure 2-80 The set format

(4). ¢ as point, press **Separator** → **No** , the example is as follows:



Figure 2-81 The set format

(5). • as point, press **Separator** → **Space** , the example is as follows:



Figure 2-82 The set format

(6). ¢ as point, press **Separator** → **Space** , the example is as follows:



Figure 2-83 The set format

2. Language Setup

The DG3000 Series Generator offers multiple languages for user to choose. To Select Language, press **Utility** and then **Language** to select the language. The Procedure is as follows:

Press **Utility** → **System Setup** → **Language**, to change the language.

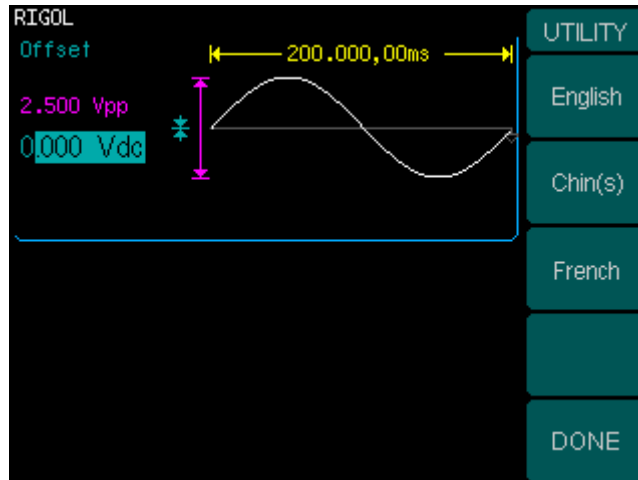

Figure 2-84
Language Setting Menu

3. To Return to Default Setting

Press **Utility** → **System Setup** → **Set to Default**, to set the system to the default one. The default settings of the system are as follows:

Table 2-36 Default Parameter Setting

Output	Default
Function	Sine Wave
Frequency	1kHz
Amplitude/Offset	5 Vpp 0.000Vdc
Unit	Vpp
Terminals	High Z
Auto Adjustment	On

Modulation	Default
Carrier	1kHz Sine Wave
Modulating	100Hz Sine Wave
AM Depth	100%
FM Deviation	100Hz
FSK Hop Frequency	100Hz
FSK Frequency	10Hz
Modulation State	Off

Sweep	Default
Start/Stop Frequency	100Hz/1kHz
Time	1s
Mode	Linear
State	Off

Burst	Default
Frequency	1kHz
Count	1Cycle
Period	10ms
Phase	0°
State	Off

System	Default
*power off calling	*Disabled
Display	On
Error Array	Clear Error
Storage State and any	No change
Output State	Off

Trigger	Default
Source	Internal

Remote I/O Configuration	Default
*GPIB Address	*1
*I/O	*GPIB (IEEE—488)
*Baud Rate	*9600 Baud
*Parity	*No (8 bits)
*Signal Exchange	*DTR

Calibration	Default
State	Coded

The parameter with an asterisk (*) is stored in the Non-Volatile Memory.

4. Display Control

Press **Utility** → **System Setup** → **Display Control**, to enter the following menu.

Figure 2-85 Table 2-37 Display Parameter Setting



Function Menu	Settings	Explanation
Contrast Control		Set the Contrast parameter
Color	Fore	Adjust the Fore, Inverse, Back and Letter's color parameter value
	Inverse	
	Back	
	Letter	
Skin	Normal	Select one of the Skins
	Classic	
	Modern	
	Sample	

The system offers different skins by setting the fore, inverse, back and letter colors. As is shown in table 2-38, user can define its own skin by setting the values.

Table 2-38 the default Color Setting for different skins

Skin \ Color	Fore	Inverse	Back	Letter
Normal	26	63	5	11
Classic	3	62	31	2
Modern	33	62	27	32
Sample	13	62	39	12

Test

Press **Utility** → **Test/Cal** , to enter the following menu.

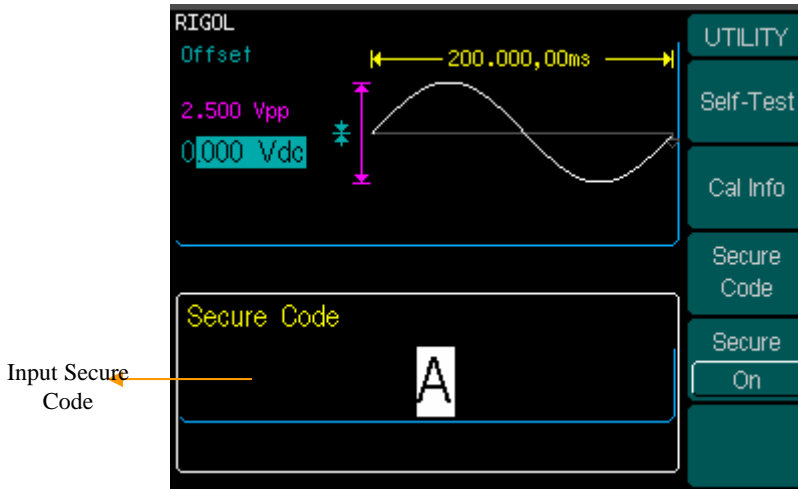

Figure 2-86
Test/Cal function Menu

Figure 2-87



Table 2-39 Test Setting Menu

Function Menu	Settings	Explanation
Self -Test		Perform System Self-Test
Cal Info		Show the information for Calibration times and other related ones
Secure Code		Input the code for Secure calibration
Secure	On Off	Turn On Secure Setting, disables the calibration by anyone Turn Off Secure Setting, enables the calibration by anyone

1. Self-Test

Press **Utility** → **Test/Cal** → **Self-Test**, to perform self-testing.

When the instrument is powered, the system will perform self-testing automatically.

This limited test can test if the instrument could work ordinarily.

To perform general test, 15 second is need. If all the tests have been passed, you can use the generator freely.

If general test has been passed, the screen will show "Self-Test Passed"; if failed, it will tell you self-test failed and display err message.

2. Cal Info

Info mainly includes the calibration times and the edition.

Please note that the generator has been calibrated before it is shipped. When you turn on a new instrument, the default number of calibration is 0.

The edition version is the updating information of the edition; the latest version can be reached at the company's website: www.rigol.com.

3. Secure Code

This function is used to prevent unauthorized or accidental calibration to the generator. When the generator is firstly shipped to the user, it is secured. You have to unlock it before calibrating the instrument.

Press **Utility** → **Test/Cal** → **Secure Code**, and enter the right password. The system will display "The secure code is right, and the secure is closed. The instrument is now unsecured". **Secure Off** will appear.

The default password is "**DG3000**". It is stored in the Non-Volatile Memory, and will not change when the instrument is powered off or the Remote I/O is reset.

Figure 2-88



Table 2-40 Perform the Calibration Performance

Function Menu	Settings	Explanation
Perform Cal		Perform the System Calibration

4. Perform the Calibration

Press **Utility** → **Test/Cal** → **Secure Code**, and input the right password. The menu in Figure 2-89 will show. Choose **Perform Cal**, and enter the menu shown in Table 2-41.

Figure 2-89

Table 2-41 Calibration Start menu



Function Menu	Settings	Explanation
Setup Number		Choose the steps of the Calibration.
Begin		Begin Calibration
End Cal		Finish Calibration and return the upper menu.

To perform the calibration begin with from step one, press **Begin** button. The operation menu is as follows in Table 2-42.

Figure 2-90 Table 2-42 Calibration Parameter Setting



Function Menu	Settings	Explanation
Setup Number		Perform the Calibration Step selected.
Meas'd Frequency		"Meas'd Freq" is the instruction for current step, which can not be operated on.
Enter Value		Input the value calibrated.
CANCEL STEP		Cancel the current calibration step.

To perform calibration from step N, choose **Setup Number**, input the desired calibration step and press **Begin**. The calibration will start from step N. The parameter to be calibrated is closely related to the waveform parameter. For example, the main calibration parameters for pulse are frequency, voltage, Duty Cycle and the time. Each parameter has to be calibrated.



Note: Please calibrate the instrument under specialist's supervision. If any malfunction occurs after the calibration, please contract the local Rigol support center.

How to Use the Built-in Help System

You can get a particularly help for every button on the front panel by using the built-in help system. Or you can get help about the operation of the front panel buttons with the Help List.

Press **Help** to enter the following interface.

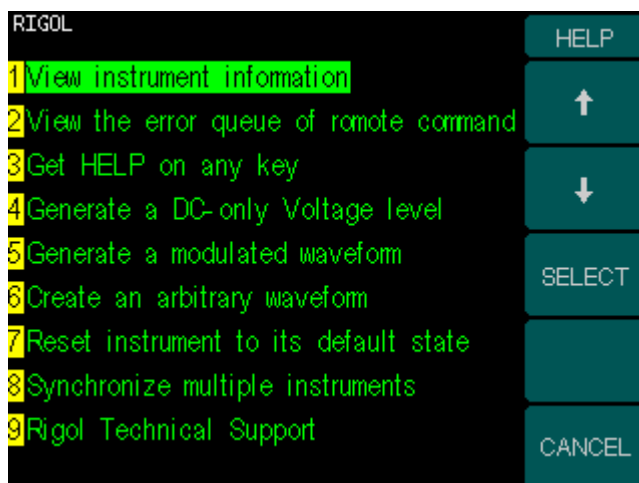

Figure 2-91
Help Menu

Figure 2-92



Table 2-43 Help Menu

Function Menu	Settings	Explanation
↑		Cursor upward to select
↓		Cursor downward to select
Select		Select to Read the Information

Table 2-44 Help Menu

Function Menu	Settings	Explanation
Select		Select to Read the Information
↑		Page Up
↓		Page Down
→		Cursor Downward to select
←		Cursor Upward to select

1. View the last message display

View the last message display

2. View the remote Command error queue

View the remote command error queue.

3. Get HELP on any key

To get context-sensitive help on any front-panel key or menu softkey, press and hold down that key.

4. Generate a DC-only Voltage level

- (1). Press **Utility** and select **DC On**.
- (2). Use **Offset** to enter the desired voltage level.
- (3). Choose **DC On/Off** → **DC Off**, or press any function key to resume normal waveform operation.

5. Generate a modulated Waveform

- (1). Configure the Carrier waveform by selecting the waveform shapes, frequency, amplitude, etc. Pulse can be modulated only using PWM; Noise and DC can not be modulated.
- (2). Configure the modulating waveform by pressing the **Mod** key.
- (3). To change the Carrier parameter, press the lighted function key (**Sine**, **Square** etc).
- (4). To turn off the modulation, press the lighted **Mod** key.

6. Create an arbitrary waveform

- (1). Press **Arb** and then "Create New".
- (2). Enter the desired period, voltage limit, and number of points and then press "Edit Points", the first two points were defined for you.
- (3). Rotate the knob to select the desired point for editing and then use **Time** and **Voltage** to define the point. Press **Insert Point** to insert additional points as needed.
- (4). Repeat until all points are defined. The waveform editor connects the last point of the waveforms the voltage level of Point #1 automatically to create a continuous waveform. The time value of the last point that can be defined in the waveform must be less than the specified period.
- (5). Press **End/Store** to store the waveform and exit the waveform editor.

7. Reset instrument to its default state

- (1). Press **Store/Recall**
- (2). Select **Set to Default**
- (3). Select **Yes** to return to factory default state

8. Synchronize multiple instruments

By using the external I/O of the generator, connect the instrument to other kinds of instruments, to perform synchronous control.

9. Rigol Technology Support

To obtain technical support, contact the local **RIGOL** Support Center or go to **RIGOL** website: www.rigol.com
Resort to Chapter 5 for more details.

Chapter 3 : Application & Examples

To help the User grasp how to use the Function/ Arbitrary Waveform Generator more efficiently, we will cover some examples in detail. All the examples below use the default setting of the instrument.

This chapter will cover the following topics:

- Example1 : To generate a Sine Wave
- Example2 : To generate a Square Wave
- Example3 : To generate a Ramp Wave
- Example4 : To generate a Pulse Wave
- Example5 : To generate a Noise Wave
- Example6 : To generate a stored Wave
- Example7 : To generate an Arbitrary Wave
- Example8 : To generate an AM Wave
- Example9 : To generate a FSK Wave
- Example10 : To generate a PWM Wave
- Example11 : To generate a linear Sweep Wave
- Example12 : To generate a Burst Wave

Example 1: To generate a Sine Wave

How to generate a Sine Waveform with 20 kHz frequency, 10mVpp Amplitude and 0Vdc Offset.

Steps:

1. Set the Frequency.

(1) Press **Sine** → **Freq** and choose Frequency which will display in reverse white color.

(2) Input "20" from the keypad and choose the unit "kHz". The Frequency is set to be 20 kHz.

2. Set the Amplitude.

(1). Press **Ampl** to choose the **Ampl** selection which will display in reverse color.

(2). Enter "10" from the keypad and choose the unit "mVpp". The Amplitude is set to be 10mVpp.

3. Set the Offset.

(1). Press **Offset** to choose the **Offset** selection which will display in reverse color.

(2). Enter "0" from the keypad and choose the unit "Vdc" to set the Offset 0Vdc.

When the Frequency, Amplitude and Offset are set, the waveform generated is shown in Figure 3-1.

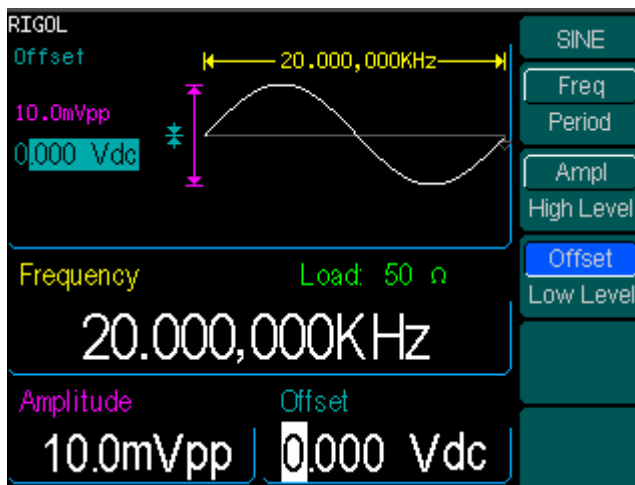

Figure 3-1
Sine Waveform Output

Example 2: To generate a Square Wave

How to generate a Square waveform with 1 MHz frequency, 2.0Vpp amplitude, 10mVdc offset and 30% Duty Cycle.

Steps:

1. Set the Frequency.

(1) Press **Square** → **Freq** and choose Frequency which will display in reverse color.

(2) Input "1" from the keypad and choose the unit "MHz" to set the Frequency to be 1MHz.

2. Set the Amplitude.

(1). Press **Ampl** and choose the **Ampl** selection which will display in reverse color.

(2). Enter "2" from the keypad and choose the unit "Vpp" to set the Amplitude to be 2 Vpp.

3. Set the Offset.

(1). Press **Offset** to choose the **Offset** selection which will display in reverse color.

(2). Enter "10" from the keypad and choose the unit "mVdc" to set the Offset to be 10mVdc.

4. Set the Duty Cycle.

(1). Press **Duty** to choose **Duty Cycle** which will display in reverse color.

(2). Enter "30" from the keypad and choose the unit "%" to set the Duty Cycle to be 30%.

When the Frequency, Amplitude Offset and Duty Cycle are set, the waveform generated is shown in Figure 3-2.

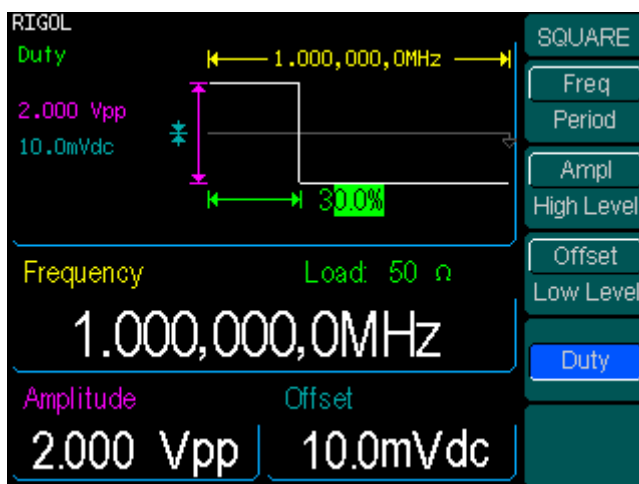

Figure 3-2

Square Waveform Output

Example 3: To generate a Ramp Wave

How to generate a Ramp waveform with 10ms Period, 100mVpp Amplitude 20mVdc offset and 80% Symmetry.

Steps:

1. Set the Period.

- (1) Press **Ramp** → **Freq** and choose Period which will display in reverse color.
- (2) Input "10" from the keypad and choose the unit "s" to set the Period to be 10ms.

2. Set the Amplitude.

- (1). Press **Ampl** and choose the **Ampl** selection which will display in reverse color.
- (2). Enter "100" from the keypad and choose the unit "mVpp" to set the Amplitude to be 100mVpp.

3. Set the Offset.

- (1). Press **Offset** to choose the **Offset** selection which will display in reverse color.
- (2). Enter "20" from the keypad and choose the unit "mVdc" to set the Offset to be 20mVdc.

4. Set the Symmetry.

- (1). Press **Symmetry** and choose **Symmetry** which will display in reverse color.
- (2). Enter "80" from the keypad and choose the unit " %" to set the Symmetry to be 80%.

When the Frequency, Amplitude Offset and Symmetry are set, the waveform generated is shown in Figure 3-3.

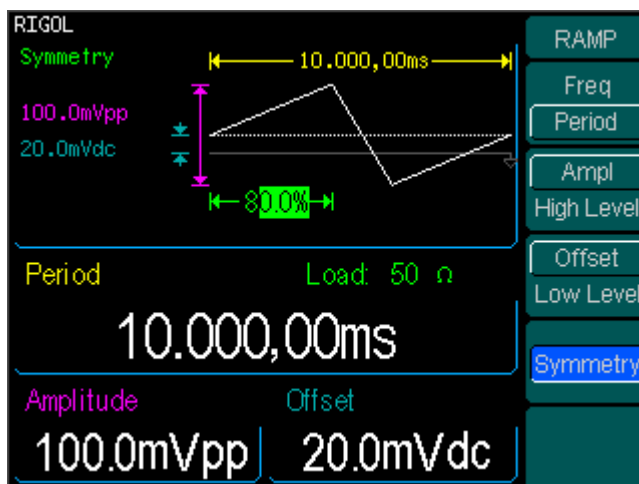

Figure 3-3
Ramp Waveform Output

Example 4: To generate a Pulse Wave

How to generate a Pulse waveform with 5kHz Frequency, 50mV High Level, -5mV Low Level, 20 μ s Pulse Width and 10ns Edge Time.

Steps:

1. Set the Frequency.

(1) Press **Pulse** → **Freq** and choose **Freq**, which will display in reverse color.

(2) Input "5" from the keypad and choose the unit "kHz" to set the Frequency to be 5kHz.

2. Set the Amplitude.

(1). Press **Ampl** and choose the **Ampl** selection which will display in reverse color.

(2). Enter "50" from the keypad and choose the unit "mV" to set the High Level to be 50mV.

3. Set the Offset.

(1). Press **Offset** to choose the **Offset** selection which will display in reverse color.

(2). Enter "-5" from the keypad and choose the unit "mV" to set the Low Level to be -5mV.

4. Set the Pulse Width.

(1). Press **Pulse Width** and choose **Pulse Width** which will display in reverse color.

(2). Enter "20" from the keypad and choose the unit " μ s" to set the Pulse Width to be 20 μ s.

5. Set the Edge Time.

(1). Press **Edge Time** and choose **Edge Time** which will display in reverse color.

(2). Enter "10" from the keypad and choose the unit "ns" to set the Edge Time to be 10ns.

When the Frequency, Amplitude, Offset, Pulse Width and Edge Time are set, the waveform generated is shown in Figure 3-4.

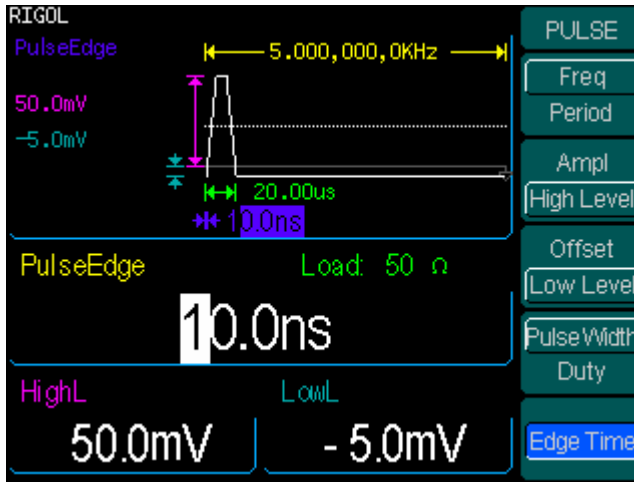

Figure 3-4
Pulse Waveform Output

Example 5: To generate a Noise Wave

How to generate a Noise waveform with 30mVpp Amplitude and 10mVdc Offset.

Steps:

1. Set the Amplitude.

(1). Press **Ampl** and choose the **Ampl** selection which will display in reverse color.

(2). Enter "30" from the keypad and choose the unit "mVpp" to set the Amplitude to be 30mVpp.

2. Set the Offset.

(1). Press **Offset** to choose the **Offset** selection which will display in reverse color.

(2). Enter "10" from the keypad and choose the unit "mVdc" to set the Offset to be 10mVdc.

When the Amplitude and Offset are set, the waveform generated is shown in Figure 3-5.

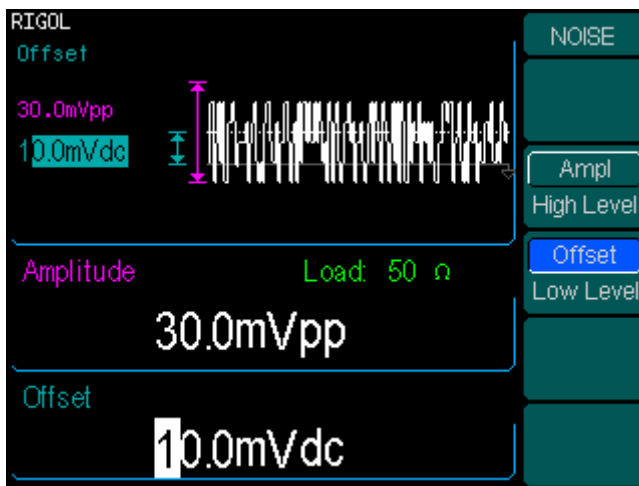

Figure 3-5
Noise Waveform Output

Example 6: To generate Arbitrary Waveform

How to generate an arbitrary waveform (Sinc) with 8MHz Frequency, 4Vrms Amplitude and 0Vdc Offset.

Steps:

1. Set the Type of the Arbitrary Waveform.

(1) Press **Arb** → **Sel Wform**, to choose the built-in waveform.

(2) Press **Built-In** → **Sinc**. There are five built-in arbitrary waveforms. Choose Sinc, and press any key to return to **Arb** Main Menu.

2. Set the Frequency.

(1) Press **Pulse** → **Freq** and choose **Freq**, which will display in reverse color.

(2) Input "8" from the keypad and choose the unit "MHz" to set the Frequency to be 8MHz.

3. Set the Amplitude.

(1). Press **Ampl** and choose the **Ampl** selection which will display in reverse color.

(2). Enter "4" from the keypad and choose the unit "Vrms" to set the Amplitude to be 4 Vrms.

4. Set the Offset.

(1). Press **Offset** to choose the **Offset** selection which will display in reverse color.

(2). Enter "0" from the keypad and choose the unit "Vdc" to set the Offset to be 0Vdc.

When the Arbitrary Waveform's Type, Frequency, Amplitude and Offset are set, the waveform generated is shown in Figure 3-6.

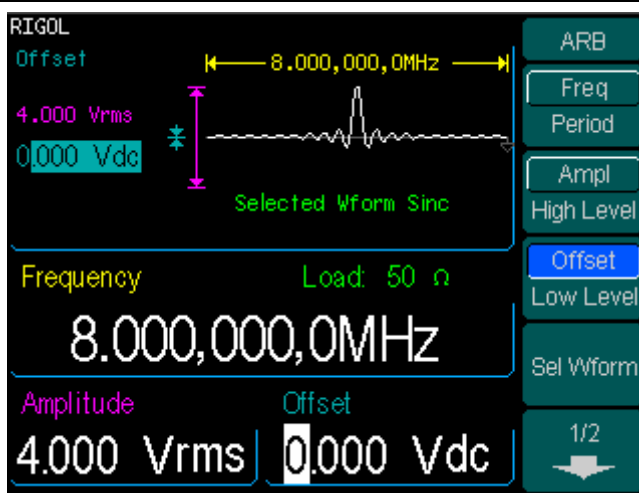

Figure 3-6

Sinc Waveform Output

Right now, the selected waveform is appointed to the **Arb** Key. This waveform will be generated once the key is pressed. To make sure what kinds of waveform is selected, please press **Arb** Key.

Example 7: To Generate an Arbitrary Waveform

How to generate an arbitrary waveform. (The Self-Defined is Ramp)

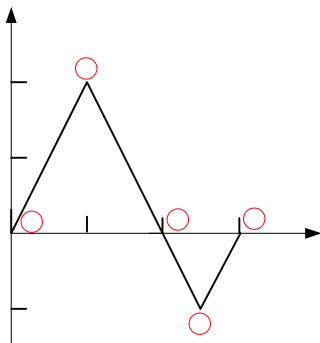

Figure 3-7
Arbitrary Waveform Output

Steps:

1. Create a new Waveform:

Press **Arb** → **Edit Wform** → **Create New**, to activate the waveform editor function.
The waveform is defined by setting every point's time and voltage.

2. Set the period.

(1) Press **Cycle Period** and choose **Cycle Period** which will display in reverse color.
(2) Input "12" from the keypad and choose the unit "μs" to set the Period to be 12μs.

3. Set the Voltage Limit.

(1) Press **HighV Limit**, and enter "4" from the keypad, choose the unit "V", to set the Level High to be 4V.

(2) Press **LowV Limit**, and enter "-2" from the keypad, choose the unit "V", to set the Level L to be -2V.

4. Set the Number of the Initializing Points

Set the Initializing Point Number "4".

5. Choose the Interpolation Method.

Press **Interp.** → **Interpation On**, to perform linear connection between the points.

V
4 2
2
0 1 3
4 8
-2 4

6. Edit the Waveform Points.

Edit every point's Voltage and Time to define a waveform. If needed, insert or delete a point.

Press #Points, use the knob or the keypad to shift the point number. The voltage and time of every point is defined below in Table 3–1.

Table 3-1 The Setting of Time and Voltage of every point

Point	Time	Voltage
1	0s	0V
2	4 μ s	4V
3	8 μ s	0V
4	10 μ s	-2V

7. To save the Waveform.

Press Store in Non-Volatile → ARB1 → Save to store the waveform in the Non-Volatile Memory. There are four places available.

The waveform is generated through the steps above. The waveform is shown in Figure 3-8.

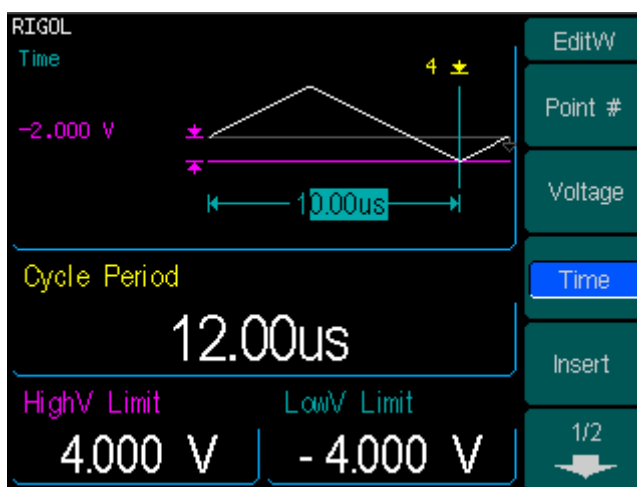

Figure 3-8

The Self-Defined Ramp Waveform

Example 8: To Generate an AM Waveform

How to generate an AM Waveform with 70% Depth. The Carrier is a Sine Wave with 2.5 kHz Frequency, and the modulating Wave is a Sine Wave with 150 Hz Frequency.

Steps:

1. Choose the Carrier Function:

Press **Sine**, and choose the Sine Waveform as the Carrier Wave.

The default setting of the Source is Internal.

2. Set the Frequency, Amplitude and Offset.

(1) Press **Freq** and choose **Freq** which will display in reverse color. Input "2.5" from the keypad and choose the unit "kHz" to set the Frequency 2.5 kHz.

(2) Press **Ampl** and choose **Ampl** which will display in reverse color. Input "2" from the keypad and choose the unit "Vpp" to set the Amplitude 2 Vpp.

(3) Press **Offset** and choose **Offset** which will display in reverse color. Input "0" from the keypad and choose the unit "Vdc" to set the Offset 0Vdc.

3. Set the Modulation Type AM.

Press **Mod** → **Type** → **AM**, choose **AM**. Please notice that the message shown on the top left side of the screen is "AM".

4. Set the Modulation Depth

Press **AM Depth**, use the keypad to enter "70", choose the unit "%", setting the Modulation Depth 70%.

5. Set the AM Frequency

Press **AM Freq**, use the keypad to enter "150", choose the unit "Hz", setting the AM Frequency 150Hz.

6. Choose the Modulating Waveform.

Press **Shape** → **Sine**, to choose Sine Waveform as the Modulating Waveform.

Please note that the State Message on the top left side of the screen shows "Sine".

At this time, the Generator generates the specified AM waveform. The Waveform is shown in Figure 3-9.

7. Turn off the Modulation Function.

Press the lighted **Mod** Key to turn off the Modulation Function.

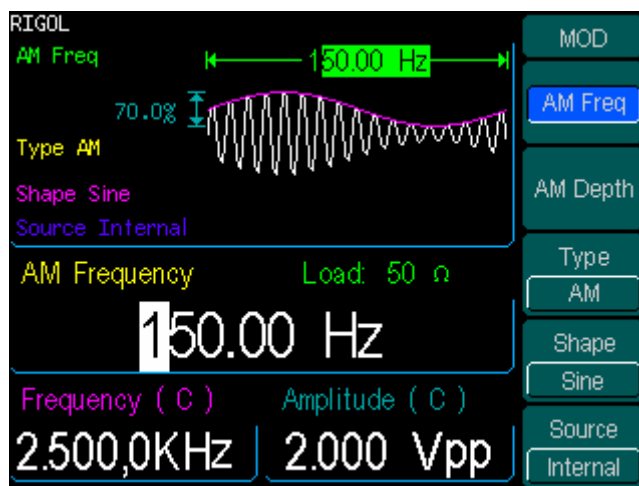

Figure 3-9
The AM Output

Example 9: To Generate an FSK Waveform

How to generate an FSK Waveform with 200Hz FSK Rate. The Carrier is a Sine Wave with 10 kHz Frequency, and the Hop Wave is a Sine Wave with 800 Hz Frequency.

Steps:

1. Choose the Carrier Function:

Press **Sine**, and choose the Sine Waveform as the Carrier Function.

The default setting of the Source is Internal.

2. Set the Frequency, Amplitude and Offset.

(1) Press **Freq** and choose **Freq** which will display in reverse color. Input "10" from the keypad and choose the unit "kHz" to set the Frequency 10 kHz.

(2) Press **Ampl** and choose **Ampl** which will display in reverse color. Input "2" from the keypad and choose the unit "Vpp" to set the Amplitude 2 Vpp.

(3) Press **Offset** and choose **Offset** which will display in reverse color. Input "0" from the keypad and choose the unit "Vdc" to set the Offset 0Vdc.

3. Set the Modulation Type FSK.

Press **Mod** → **Type** → **FSK**, choose FSK. Please notice that the message shown on the top left side of the screen is "FSK".

4. Set the FSK Rate

Press **FSK Rate**, use the keypad to enter "200", choose the unit "Hz", setting the FSK Rate 200Hz.

5. Set the Hop Frequency

Press **Hop Freq**, use the keypad to enter "800", choose the unit "Hz", setting the Hop Frequency 800Hz.

At this time, the Generator generates the specified AM waveform. The Waveform is shown in Figure 3-10.

6. Turn off the Modulation Function.

Press the lighted **Mod** Key to turn off the Modulation Function.

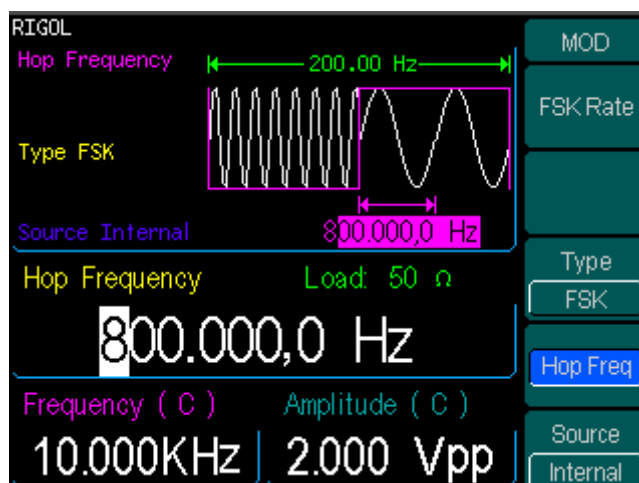

Figure 3-10
The FSK Output

Example 10: To Generate a PWM waveform

To generate a PWM waveform with 1kHz frequency, 300us pulse width, the carry wave is 130Hz, and the width deviation is 200us.

Steps:

1. Choose **Pulse** as the carry wave, the default type of the source is internal.
2. Set the frequency, the amplitude and the offset of the carry wave.
 - (1). Press **Freq**, input the digit "1", choose the unit "kHz", set the frequency to be 1kHz.
 - (2). Press **Ampl**, input the digit "4", choose the unit "Vpp", set the amplitude to be 4Vpp .
 - (3). Press **Offset**, input the digit "0", choose the unit "Vdc", set the offset to be 0Vdc.
 - (4). Press **DtyCyc**, input the digit "300", choose the unit "us", set the duty cycle to be 300us.
 - (1). Press **Edge**, input the digit "40", choose the unit "ns", set the edge to be 40ns.
3. Choose the modulation type PWM.
Press **Mod**, enter the PWM interface.
4. set the modulation frequency
Press **PWM Freq**, input the digit "130", choose the unit "Hz", set the modulation frequency to be 130Hz.
5. set the width deviation
Press **Width Dev**, input the digit "200", choose the unit "us", set the width deviation to be 200us.
6. Choose the modulation wave
Press **Shape**, choose "sine" as the modulation wave. Then the generator will put out a PWM waveform according to the parameters we have just set.
7. Close the modulation function
Press **Mod**, close the modulation function.

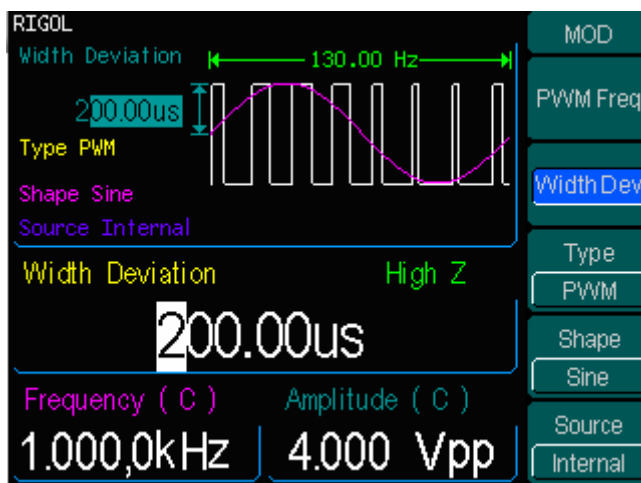

Figure 3-11
The PWM output

Example 11: To Generate a Linear Sweep Waveform

How to generate a Sine Sweep Waveform whose frequency starts from 100Hz to 10KHz. Use Internal Trigger Mode, Linear Sweep, and the Sweep is 1s.

Steps:

1. Choose the Sweep Function:

Press **Sine**, and choose the Sine Waveform as the Sweep Function.

The default setting of the Source is Internal.

2. Set the Frequency, Amplitude and Offset.

(1) Press **Freq** and choose **Freq** which will display in reverse color. Input "5" from the keypad and choose the unit "kHz" to set the Frequency 5 kHz.

(2) Press **Ampl** and choose **Ampl** which will display in reverse color. Input "2" from the keypad and choose the unit "Vpp" to set the Amplitude 2 Vpp.

(3) Press **Offset** and choose **Offset** which will display in reverse color. Input "0" from the keypad and choose the unit "Vdc" to set the Offset 0Vdc.

You can view the Sweep Waveform parameters in the Graph Mode

3. Set the Sweep Mode.

Press **Sweep** → **Linear** and choose **Linear**. Please notice that the message shown on the top left side of the screen is "Sweep Type Linear".

4. Set the Sweep Time

Press **SwpTime**, use the keypad to enter "1", choose the unit "s", setting the Sweep Time 1s.

5. Set the Start Frequency

Press **Start Freq**, use the keypad to enter "100", choose the unit "Hz", setting the Start Frequency 100Hz.

6. Set the Stop Frequency

Press **Stop Freq**, use the keypad to enter "10", choose the unit "kHz", setting the Stop Frequency 10 kHz.

At this time, the Generator generates the specified Sweep waveform whose frequency starts from 100Hz and stops at 10 kHz. The Waveform is shown in Figure

3-12.

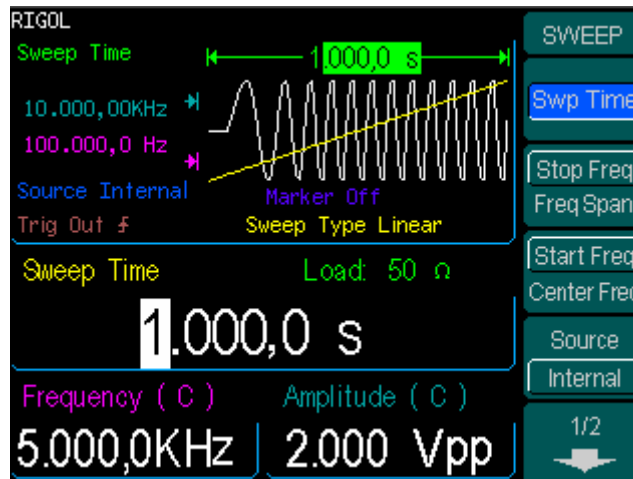

Figure 3-12
The Sweep Waveform Output

Instructions

If necessary, you can set the frequency Limits by setting the Center Frequency and the frequency range. These parameters are like the Start and Stop frequency, which will provide more flexibility. To generate the same waveform, set the Center Frequency 5.050 kHz, and frequency range 9.900 kHz.

Example 12: To Generate a Burst Waveform

How to generate a Burst Waveform of 3 Cycles. The period is 10ms. You can not change other parameters in the default setting: Internal Source and 0 degree Phase.

Steps:

1. Choose the Burst Function:

Press **Square**, and choose the Square Waveform as the Burst Function.

The default setting of the Source is Internal.

2. Set the Frequency, Amplitude and Offset.

(1) Press **Freq** and choose **Freq** which will display in reverse color. Input "5" from the keypad and choose the unit "kHz" to set the Frequency 5kHz.

(2) Press **Ampl** and choose **Ampl** which will display in reverse color. Input "5" from the keypad and choose the unit "Vpp" to set the Amplitude 5 Vpp.

(3) Press **Offset** and choose **Offset** which will display in reverse color. Input "0" from the keypad and choose the unit "Vdc" to set the Offset 0Vdc.

You can view the Sweep Waveform parameters in the Graph Mode

3. Set the Sweep Mode.

Press **Burst** → **N Cycle**, choose **N Cycle** Mode. Please note that the message shown on the top left side of the screen is "Type N Cycle".

4. Set the Burst Period

Press **Burst Period**, use the keypad to enter "10", choose the unit "ms" and set the Period 10 ms (Please note the icon).

5. Set the Start Phase

Press **Start Phase**, use the keypad to enter "0", choose the unit "°", setting the Start phase 0°.

6. Set the Burst Cycles

Press **Burst Cycles**, use the keypad to enter "3", choose the unit "Cy", setting the Burst Cycle 3.

7. Set the Delay

Press **Delay**, use the keypad to enter "200", choose the unit "µs", setting the Burst

Delay 200 μ s.

At this time, the Generator generates the specified 3- Cycle Burst waveform with a period of 10ms. The Waveform is shown in Figure 3-13.

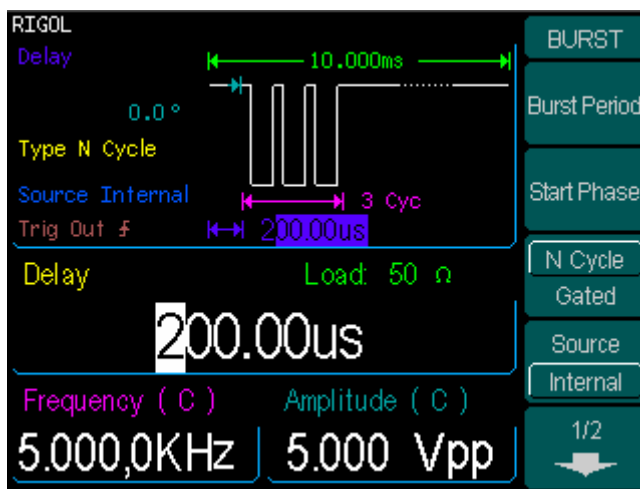

Figure 3-13
The Burst Waveform Output

Chapter 4 : Prompt messages & troubleshooting

Prompting Message

Common Prompt Message

Need Help? Press and hold down any key.

Prompt Message 1. While using the instrument, users can get help by using the method above.

Settings are restored from last power-down.

Prompt Message 2. This is to inform the user that all the settings have been restored and the user can operate the instrument normally.

Selected interface is USB, no USB device detected!

Prompt Message 3. When the instrument is powered, it detects that the current I/O is USB, and informs the user that no new USB device is detected.

No Changes

When the waveform parameter is being altered, if the user cancels the operation, the message will prompt.

Selected arb is ExpRise / ExpFall / NegRamp / Sinc / Cardiac.

This is to inform the user about the selected arbitrary waveform type. To change it, press **Sel Wform**.

Please Wait...

It takes time to save or recall data, and this message is to tell the user to wait.

First, set the allover waveform parameters.

To inform the user, set the general waveform parameter first. Once finished, set the parameters for other points.

Edit the existing waveform parameters.

Perform the waveform edit operation, and inform the user that operation can be taken to edit the current waveform parameter.

The selected arbitrary waveform is Volatile.

Inform the user that the selected waveform is Volatile.

Restore all instrument settings to factory defaults?

If user wants to reset the instrument to the default setting, the system will prompt this message, to confirm the operation, in case of accidental mistake.

All settings are restored to factory defaults:

When all the settings of the instrument have been reset to default state, this message will prompt to inform the user.

Storing waveform, please wait...

Inform the user that the saving operation is in process.

Waveform has been stored, as required.

Save the waveform to the specific place according to the user's request. Once the waveform is saved, this message prompts.

Performing Self-Test, Please wait...

When the Self-Test is performed, this message will prompt to inform the user to wait, since it takes time.

Self-Test Passed.

When the Self-Test is finished, the result will be reported to the user. If the Self-test has been passed, this message will prompt.

The Code is right. The Secure is closed. The instrument now is UNSECURED.

Inform the user that the password is correct and the user can calibrate the instrument now. The instrument is unsecured.

Instrument triggered.

The manual trigger mode is activated, and the expected burst or sweep will be generated.

Selected modulating arb is **:

Inform the user of the information about the selected modulating waveform.

Calibration Count=0, Reversion=04040109:

Inform the user of the Calibration time and the version. Before the instrument is shipped, it has already been calibrated. When you power a new instrument, the default calibration time is 0. The latest version can be reached at the company's website: www.rigol.com.

Calibrating, Please wait...

In the Calibration menu, inform the user to wait when the instrument is preparing to calibrate.

File doesn't exist!

When deleting a file, to inform the user that the file does not exist.

Complete. Waveform data have been changed:

Inform the user that the file has been recalled and the waveform setting is displayed.

Complete. Arb Waveform data have been changed:

Inform the user that the file has been recalled and the arbitrary waveform setting is displayed.

Please select type.

When storing the file and the storage type is all, inform the user to choose the

storage type.

Insufficient space. Fail to Save.

If the file to be stored is too large, and the Non-Volatile Memory has no enough space, the new file can not be stored. This is to inform the user that the storage operation failed.

Fail to read file.

If there is no file in the place the user selects, no file can be read and this message is to inform the user that the file recall operation failed.

Please select a valid File.

If the selected place is empty when recall or delete a file, this message will appear.

No Arbitrary waveform in buffer.

If the buffer has no Arbitrary waveform and user wants to store the Arb waveform data into the Flash or U Disk, this message will appear.

State extension".rsf"; data extension".rdf".

This is the message appear when the user enter the Store/Recall interface.

Delete the file?

Confirm the deletion operation, in case of accidental operation.

Cover the file ?

If the current place has already been used when the user wants to store the file, this message will appear to confirm the operation. If the user continues, the old file will be covered. Press "Yes" to continue; Press "Cancel" to select the place again.

Detect a mobile disk.

The U Disk has been successfully installed, and the system has detected the portable device.

Mobile disk is moved.

The portable disk has been removed.

Can't Write this File to system.

This message appears when the operation of burning menu or programs into the system from the U Disk fails.

File is too big.

If the menu or programs are too large to be burnt into the system from the U Disk, this message appears to inform the user of the overflow.

Invalid File, Fail to update.

When using the U Disk to update the system, if the updating file is invalid, this message will appear, telling the user that the system updating operation can not be performed.

Updating is completed. Restart the instrument.

If the System updating operation is successful using the U disk, this message will appear. The instrument has to be reactivated to update the settings. It is also to

RIGOL

inform the user that if a technical problem occurs after the updating, contact the RIGOL technician for support.

Invalid code.

When the user is updating the system, if the password is wrong, this message will appear.

Valid code. System update is permitted

When the user is updating the system, if the password is correct this message will appear.

Wave file will cover.

If the arbitrary waveform to be stored is larger than 128K, the other places will be used to store the waveform.

Mobile disk installation is error!

U disk installation failed, and the system could not identify it.

Error Message

Incorrect secure code, please try again.

User has to enter the correct password before they can calibrate the instrument. If the password entered is incorrect, this message will appear to inform the user to reenter the password.

Please first complete step:**

Before the instrument is calibrated, if the user wants to perform the selected calibration procedure, this is to inform the user to start from step**.

Select units to enter value or press CANCEL.

When a parameter is input, inform the user "Choose the parameter unit" to finish the change to the parameter; or the user can press **Cancel** button to cancel the current operation.

Trigger ignored.

If groups of GET commands or * Trigger is received, the system will ignore the grouped GET commands to secure the right source.

Instrument is in remote mode. Press Local.

If the instrument is in the Remote Mode, the front panel will be nullified. Press **Local** (also **Burst**), to shift the instrument mode into local, so that the front panel can work.

Initial # of points upper limit=524,288.

The upper limit of the initial points is 524,288. If the specified waveform has more than 524,288points, the system will adjust the number to 524,288 automatically.

Conflict Setting

Turned off infinite burst.

Infinite burst is allowed only when the source is external or manual. The upper limit of the burst cycle is 1,000,000.

Trigger source changes to Ext/Manual.

Only when the External or Manual Trigger Source is selected, infinite burst is allowed.

Burst period increased to fit entire burst.

The PRI of Period is higher than that of the Burst Period. As long as the burst period does not reach its maximum, the generator will increase the burst period to cater to the need of the specific burst cycle or waveform frequency.

Burst count reduced.

If the burst period has reached its maximum, burst count will decrease to cater to the need of the specified waveform frequency.

Trigger delay reduced to fit entire burst.

Trigger delay will be reduced to fit the current burst period and burst count. Trigger delay is the time between the time when trigger is received and the start of the burst.

Sorry, unable to N-cycle burst with noise.

Noise can not be used in the trigger burst mode; it can only be used in the gated burst.

Triggered burst not available for noise.

Noise can not be used in the trigger burst mode; it can only be used in the gated burst.

Trigger ignored -OUTPUT is off.

When the OUTPUT is disabled, the Trigger Output will be disabled automatically.

Trigger output connector used by FSK.

If the FSK is activated and the Source is external, no "Trigger Output" is allowed.

Trigger output connector used by burst gate.

If the gated burst mode is activated and burst is also activated, no "Trigger Output" is allowed.

Frequency is set maximum for Arb.

The maximum frequency for arbitrary waveform is 25MHz. when the waveform is turned from one that allows higher frequency to the arbitrary waveform, the system will adjust the frequency to 25MHz automatically.

Frequency is set maximum for Pulse.

The maximum frequency for pulse is 50MHz. when the waveform is turned from one that allows higher frequency to the pulse waveform, the system will adjust the frequency to 50MHz automatically.

Frequency is set maximum for ramp.

The maximum frequency for Ramp is 1MHz. when the waveform is turned from one that allows higher frequency to the Ramp waveform, the system will adjust the frequency to 1MHz automatically.

Frequency is set maximum for Burst.

For an internal burst, the minimum frequency is 2 mHz, and the maximum is 25MHz. Generator will adjust the frequency to be compatible to the currently specified one automatically.

Frequency is set minimum for Burst.

For an internal burst, the minimum frequency is 2mHz, and the maximum is 25MHz. Generator will adjust the frequency to be compatible to the currently specified one automatically.

Frequency is set minimum for FM.

When FM is activated, the minimum carrier frequency output is 5Hz. Generator will adjust the frequency to be compatible to the currently specified one automatically.

Sorry, unable to modulate Pulses.

Noise, Pulse and DC can not be modulated using AM, FM, PM, FSK or PWM methods.

Sorry, unable to modulate Noise.

Noise, Pulse and DC can not be modulated using AM, FM, PM, FSK or PWM methods.

Sorry, unable to modulate DC.

Noise, Pulse and DC can not be modulated using AM, FM, PM, FSK or PWM methods.

Sorry, unable to sweep Pulses.

Pulse, Noise and DC can not be used to generate sweep signals.

Sorry, unable to sweep Noise.

Pulse, Noise and DC can not be used to generate sweep signals.

Sorry, unable to sweep DC.

Pulse, Noise and DC can not be used to generate sweep signals.

Modulation has been turned off to allow Pulse.

Pulse, nose and DC are not allowed to generate modulated waveform. So the modulation has to be turned off to allow Pulse.

Modulation has been turned off to allow Noise.

Pulse, nose and DC are not allowed to generate modulated waveform. So the modulation has to be turned off to allow Noise

Modulation has been turned off to allow DC.

Pulse, nose and DC are not allowed to generate modulated waveform. So the modulation has to be turned off to allow DC

Sweep has been turned off to allow Pulse.

Pulse, nose and DC are not allowed to generate Sweep waveform. So the modulation has to be turned off.

Sweep has been turned off to allow Noise.

Pulse, nose and DC are not allowed to generate Sweep waveform. So the modulation has to be turned off.

Sweep has been turned off to allow DC.

Pulse, nose and DC are not allowed to generate Sweep waveform. So the modulation has to be turned off.

Manual Trigger only for Sweep, N-Cycle Burst.

Manual Trigger is only used for Sweep and N-Cycle Burst.

Trigger Source has been changed to Manual.

When Trigger is enabled, the source type turns from internal to manual.

Pulse width was reduced by period.

For a pulse waveform, the generator will adjust the waveform parameter automatically to fit the need of the pulse according to the order below: Edge time-Pulse Width-Period. In this case, the generator will reduce the pulse width to cater to the need of the period. The Edge Time is already set to the minimum value.

Edge Time was reduced by period.

For a pulse waveform, the generator will adjust the waveform parameter automatically to fit the need of the pulse according to the order below: Edge time-Pulse Width-Period. In this case, the generator will reduce the Edge Time to meet the need of the period.

Amplitude is set to limit.

For example: if a square wave with an amplitude of 5 Vrms connects to a 50Ω resistance, and was turned into a sine waveform, then the generator will change the amplitude to 3.536 Vrms automatically.

Offset has changed due to Amplitude.

In DC voltage function, voltage level is adjusted through the change of the offset, and the current amplitude will be ignored. When changed to other function, the generator will adjust the offset voltage to fit the current amplitude setting.

Deviation has been changed due to carrier frequency.

Carrier frequency should always be greater than or equal to the deviation frequency.

If the carrier frequency is set less than the deviation frequency, when FM is activated, the generator will adjust the deviation frequency to the value that the current carrier frequency allows automatically.

Duty cycle is limited at a higher frequency.

If the waveform is set Square and the frequency is set to a value which does not allow the current Duty Cycle, the Duty Cycle will be adjusted to the value that the current frequency allows automatically. For example, if the current Duty Cycle is 70%, and the frequency is changed to 60 MHz, the Duty Cycle will be changed to 50%.

For a frequency less than 25 MHz, the Duty Cycle range is 20% to 80%.

For a frequency between 25MHz and 50MHz, the Duty Cycle range is 40% to 60%;

For a frequency greater than 50 MHz, the Duty Cycle is 50%.

Other parameters were modified.

For the Pulse Waveform, the generator will adjust the following parameters automatically in the order below to generate the pulse waveform: Edge time- Pulse Width-Period. When the period changes, the Edge Time and Pulse Width will also change according to the period.

Burst type has been changed to N-Cycle.

When the Trigger Source is turn from External/ Manual to Internal, the Burst Mode should be changed to N-Cycle.

Sorry, unable to burst DC.

Generator can not use DC Voltage function to generate Burst.

Burst has been turned off to allow DC.

Generator can not use DC to generate Burst. So the Burst is turned off.

Data Overflow

Sine Wave frequency upper limit=120MHz

The Sine wave frequency upper limit is 120MHz. If the specified frequency is greater than 120MHz, the system will adjust the frequency to 120MHz automatically.

Sine Wave frequency lower limit= 1μHz

The Sine wave frequency lower limit is 1μHz. If the specified frequency is less than 1μHz, the system will adjust the frequency to 1μHz automatically.

Square Wave frequency upper limit=120MHz

The Square wave frequency upper limit is 120MHz. If the specified frequency is greater than 120MHz, the system will adjust the frequency to 120MHz automatically.

Square Wave frequency lower limit=1μHz

The Square wave frequency lower limit is 1μHz. If the specified frequency is less than 1μHz, the system will adjust the frequency to 1μHz automatically.

Ramp Wave frequency upper limit= 1MHz

The Ramp wave frequency upper limit is 1 MHz. If the specified frequency is greater than 1 MHz, the system will adjust the frequency to 1 MHz automatically.

Ramp Wave frequency lower limit= 1μHz

The Ramp wave frequency lower limit is 1μHz. If the specified frequency is less than 1μHz, the system will adjust the frequency to 1μHz automatically.

Pulse Wave frequency upper limit=36MHz

The Pulse wave frequency upper limit is 36MHz. If the specified frequency is greater than 36MHz, the system will adjust the frequency to 36MHz automatically.

Pulse Wave frequency lower limit=500μHz

The Pulse wave frequency lower limit is 500μHz. If the specified frequency is less than 500μHz, the system will adjust the frequency to 500μHz automatically.

Arb Wave frequency upper limit= 25 MHz

The Arb wave frequency upper limit is 25MHz. If the specified frequency is greater than 25MHz, the system will adjust the frequency to 25MHz automatically.

Arb Wave frequency lower limit= 1μHz

The Arb wave frequency lower limit is 1μHz. If the specified frequency is less than 1μHz, the system will adjust the frequency to 1μHz automatically.

Sine Wave period upper limit= 1 Ms

The Sine Wave Period upper limit is 1Ms. If the specified period is greater than 1Ms, the system will adjust the period to 1Ms automatically.

Sine Wave period lower limit= 8.33ns

The Sine Wave Period lower limit is 8.33ns. If the specified period is less than 8.33ns, the system will adjust the period to 8.33ns automatically.

Square Wave period upper limit= 1 Ms

The Square Wave Period upper limit is 1Ms. If the specified period is greater than 1Ms, the system will adjust the period to 1Ms automatically.

Square Wave period lower limit= 8.33 ns

The Square Wave Period lower limit is 8.33ns. If the specified period is less than 8.33ns, the system will adjust the period to 8.33ns automatically.

Ramp Wave period upper limit= 1 Ms

The Ramp Wave Period upper limit is 1Ms. If the specified period is greater than 1Ms, the system will adjust the period to 1Ms automatically.

Ramp Wave period lower limit= 1μs

The Ramp Wave Period lower limit is 1μs. If the specified period is less than 1μs, the system will adjust the period to 1μs automatically.

Pulse Wave period upper limit= 2 Ks

The Pulse Wave Period upper limit is 2Ks. If the specified period is greater than 2Ks, the system will adjust the period to 2Ks automatically.

Pulse Wave period lower limit= 16 ns

The Pulse Wave Period lower limit is 16ns. If the specified period is less than 16ns, the system will adjust the period to 16ns automatically.

Arb Wave period upper limit= 1 Ms

The Arb Wave Period upper limit is 1Ms. If the specified period is greater than 1Ms, the system will adjust the period to 1Ms automatically.

Arb Wave period lower limit= 40 ns

The Arb Wave Period lower limit is 40 ns. If the specified period is less than 40 μs, the system will adjust the period to 40 ns automatically.

Amplitude upper limit= **

Different mode has different amplitude upper limit; amplitude upper limit may vary in the same mode if the load is different.

Amplitude lower limit= **

Different mode has different amplitude lower limit; amplitude lower limit may vary in the same mode if the load is different.

High level upper limit = **

Different mode has different High Level upper limit; High Level upper limit may vary in the same mode if the load is different.

Low level lower negative limit=**

Different mode has different High Level lower limit; High Level lower limit may vary in the same mode if the load is different.

High level must be greater than Low level

High level must always be greater than Low level. If the high level is set less than the low level, the generator will set the low level 1 mV less than the high level automatically.

Duty Cycle upper/lower limit = **

In the Square mode, different frequency range corresponds to different Duty Cycle limit.

For a frequency less than 25 MHz, the range is 20% to 80%;

For a frequency between 25~50 MHz, the range is 40% to 60%;

For a frequency greater than 50 MHz, the Duty Cycle is set 50%.

Symmetry upper limit = 100.0%

In the Ramp mode, the Symmetry upper limit is 100%. If the specified symmetry is greater than 100%, the system will adjust the symmetry to 100% automatically.

Symmetry lower negative limit = 0.0%

In the Ramp mode, the Symmetry lower limit is 0.0%. If the specified symmetry is less than 0.0%, the system will adjust the symmetry to 0.0% automatically.

Pulse Width is limited by Period

The Pulse Width should be less than the difference of the period and the Edge Time.

$\text{Pulse Width} < \text{period} - 1.6 \times \text{Edge Time}$.

Edge Time is limited by Period

The specified Edge Time should be in the specified period. The generator will adjust the Edge Time to meet the need of the period. $\text{Edge Time} < 0.625 \times \text{Pulse Width}$.

Pulse width lower limit = 8ns

In the Pulse mode, the Pulse width lower limit is 8ns. If the specified pulse width is less than 8ns, the system will adjust the pulse width to 10ns automatically.

Edge Time lower limit = 5ns

In the Pulse mode, the Edge Time lower limit is 5ns. If the specified Edge Time is less

than 5ns, the system will adjust the Edge Time to 5ns automatically.

Offset upper limit= **

Different mode has different Offset upper limit; Offset upper limit may vary in the same mode if the load is different.

Offset lower negative limit = **

Different mode has different Offset lower limit; Offset lower limit may vary in the same mode if the load is different.

Initial # of points upper limit = 524,288

The number of initial points upper limit is 524,288. If the specified waveform has more than 524,288points, the system will adjust the point number to 524,288 automatically.

Initial # of points lower limit=2

The default initial point number is 2, the lower limit of the initial points. If the specified initial point is less than 2, the system will adjust the number to 2 automatically.

Point # lower limit=1

When the user is editing the point, if the input number is less than 1, the system, will inform the user to start from point #1.

Currently on the last defined point

When the user is about to edit the last defined point, this message will prompt.

Deviation cannot exceed Carrier Frequency

Carrier Frequency should always be greater than or equal to the deviation frequency.

Frequency Deviation lower limit = 5.0 HZ

Frequency deviation lower limit is 5.0Hz. If the specified Frequency deviation is less than 5.0Hz, the system will adjust the Frequency deviation to 5.0Hz automatically.

FM Frequency upper limit = 20 kHz

FM Frequency upper limit is 20 kHz. If the specified FM Frequency is greater than 20 kHz, the system will adjust the FM Frequency to 20 kHz automatically.

FM Frequency lower limit = 2mHz

FM Frequency lower limit is 2mHz. If the specified FM Frequency is less than 2mHz, the system will adjust the FM Frequency to 2mHz automatically.

Deviation plus Carrier cannot exceed maximum

The sum of the Carrier frequency and the deviation frequency should be less than or equal to the selected maximum frequency plus 100 kHz.

AM Depth upper limit = 120.0%

The AM Depth upper limit is 120.0%. If the specified AM Depth is greater than 120.0%, the system will adjust the AM Depth to 120.0% automatically.

AM Depth lower limit = 0.0%

The AM Depth lower limit is 0.0%. If the specified AM Depth is less than 0.0%, the

system will adjust the AM Depth to 0.0% automatically.

AM Frequency upper limit = 20 kHz

The AM Frequency upper limit is 20 kHz. If the specified AM Frequency is greater than 20 kHz, the system will adjust the AM Frequency to 20 kHz automatically.

AM Frequency lower limit = 2mHz

The AM Frequency lower limit is 2mHz. If the specified AM Frequency is less than 2mHz, the system will adjust the AM Frequency to 2mHz automatically.

Hop Frequency upper limit = **

Different Source types have different Hop Frequency upper limit. If the Carrier is a Square or Sine wave, the Hop Frequency upper limit is 120MHz; If the Carrier is a Ramp wave, the Hop Frequency upper limit is 1MHz; If the Carrier is an Arb wave, the Hop Frequency upper limit is 25MHz.

Hop Frequency lower limit = 1 μHz

The Hop Frequency lower limit is 1μHz. If the specified Hop Frequency is less than 1μHz, the system will adjust the Hop Frequency to 1μHz automatically.

FSK Rate upper limit = 100KHz

The FSK Rate upper limit is 100KHz. If the specified FSK Rate is greater than 100KHz, the system will adjust the FSK Rate to 100KHz automatically.

FSK Rate lower limit = 2mHz

The FSK Rate lower limit is 2mHz. If the specified FSK Rate is less than 2mHz, the system will adjust the FSK Rate to 2mHz automatically.

Phase deviation upper limit=360°

The Phase deviation upper limit is 360°. If the specified Phase deviation is greater than 360°, the system will adjust the Phase deviation to 360° automatically.

Phase deviation lower limit= 0°

The Phase deviation lower limit is 0°. If the specified Phase deviation is less than 0°, the system will adjust the Phase deviation to 0° automatically.

PM Frequency upper limit= 20 kHz

The PM Frequency upper limit is 20 kHz. If the specified PM Frequency is greater than 20 kHz, the system will adjust the PM Frequency to 20 kHz automatically.

PM Frequency lower limit= 2mHz

The PM Frequency lower limit is 2mHz. If the specified PM Frequency is less than 2mHz, the system will adjust the PM Frequency to 2mHz automatically.

Start Frequency upper limit = **

Different Source types have different Start Frequency upper limit. If the Carrier is a Square or Sine wave, the Start Frequency upper limit is 120MHz; if the Carrier is a Ramp wave, the Start Frequency upper limit is 1MHz; if the Carrier is an Arb wave, the Start Frequency upper limit is 25MHz.

Start Frequency lower limit = 1μHz

The Start Frequency lower limit is 1 μ Hz. If the specified Start Frequency is less than 1 μ Hz, the system will adjust the Start Frequency to 1 μ Hz automatically.

Stop Frequency upper limit = **

Different Source types have different Stop Frequency upper limit. If the Carrier is a Square or Sine wave, the Stop Frequency upper limit is 120MHz; if the Carrier is a Ramp wave, the Stop Frequency upper limit is 1MHz; if the Carrier is an Arb wave, the Stop Frequency upper limit is 25MHz.

Stop Frequency lower limit = 1 μ Hz

The Stop Frequency lower limit is 1 μ Hz. If the specified Stop Frequency is less than 1 μ Hz, the system will adjust the Stop Frequency to 1 μ Hz automatically.

Center Frequency upper limit = **

Different Source types have different Center Frequency upper limit. If the Carrier is a Square or Sine wave, the Center Frequency upper limit is 120MHz; If the Carrier is a Ramp wave, the Center Frequency upper limit is 1MHz; If the Carrier is an Arb wave, the Center Frequency upper limit is 25MHz.

Center Frequency lower limit = 1 μ Hz

The Center Frequency lower limit is 1 μ Hz. If the specified Center Frequency is less than 1 μ Hz, the system will adjust the Center Frequency to 1 μ Hz automatically.

Frequency span upper limit = **

With different Source type modes and center frequencies, the frequency span upper limits vary. If the Carrier is a Square or Sine wave, the Center Frequency upper limit is 119.999,999 MHz; if the Carrier is a Ramp wave, the Center Frequency upper limit is 999.999,99 kHz; if the Carrier is an Arb wave, the Center Frequency upper limit is 24.999,999 MHz.

Frequency span lower limit = **

With different Source type modes and center frequencies, the frequency span lower limits vary. If the Carrier is a Square or Sine wave, the Center Frequency lower limit is -119.999,999 MHz; If the Carrier is a Ramp wave, the Center Frequency lower limit is -999.999,99 kHz; If the Carrier is an Arb wave, the Center Frequency lower limit is -24.999,999 MHz.

Sweep Time upper limit = 500.00s

The Sweep Time upper limit is 500.00s. If the specified Sweep Time is greater than 500.00s, the system will adjust the Sweep Time to 500.00s automatically.

Sweep Time lower limit = 1.0ms

The Sweep Time lower limit is 1.0ms. If the specified Sweep Time is less than 1.0ms, the system will adjust the Sweep Time to 1.0ms automatically.

Marker is between Start and Stop Frequency

The Mark frequency should be between the start frequency and the stop frequency of the sweep; the mark frequency will be forced to fit into the range.

Phase upper limit= +360.0°

The Phase upper limit is +360.0°. If the specified Phase is greater than 360.0°, the system will adjust the Phase to 360.0° automatically.

Phase lower negative limit= 0°

The Phase lower negative limit is 0°. If the specified Phase is less than 0°, the system will adjust the Phase to 0° automatically.

of Cycles upper limit = 1,000,000 Cycle

The Cycle upper limit is 500,000Cyc. If the specified Cycle is greater than 500,000Cyc, the system will adjust the Cycle to 500,000Cyc automatically.

of Cycles lower limit = 1 Cycle

The Cycle lower limit is 1Cyc. If the specified Cycle is less than 1Cyc, the system will adjust the Cycle to 1Cyc automatically.

Trigger Period upper limit = 500.00s

The Trigger Period upper limit is 500.00s. If the specified Trigger Period is greater than 500.00s, the system will adjust the Trigger Period to 500.00s automatically.

Trigger Period lower limit = 1.0µs

The Trigger Period upper limit is 1.0µs. If the specified Trigger Period is less than 1.0µs, the system will adjust the Trigger Period to 1.0µs automatically.

Delay upper limit = 85.0s

The Delay upper limit is 85.0s. If the specified Delay is greater than 85.0s, the system will adjust the Delay to 85.0s automatically.

Delay lower limit = 0.0000s

The Delay lower limit is 0.0000s. If the specified Delay is less than 0.0000s, the system will adjust the Delay to 0.0000s automatically.

Phase Deviation Upper Limit= 360°

Phase Deviation Upper Limit is 360°. If the specified Phase Deviation is greater than 360°, the system will adjust the Phase Deviation to 360° automatically.

Phase Deviation Lower Limit= 0°.

Phase Deviation Lower Limit is 0°. If the specified Phase Deviation is less than 0°, the system will adjust the Phase Deviation to 0° automatically.

Phase Lower Limit = 0°

The Phase Lower limit is 0.0°. If the specified Phase is less than 360.0°, the system will adjust the Phase to 0.0° automatically.

Load Impedance upper limit =10kΩ

The Load Impedance upper limit is 10kΩ. If the specified Load Impedance is greater than 10kΩ, the system will adjust the Load Impedance to 10kΩ automatically.

Load Impedance lower limit = 1Ω

The Load Impedance lower limit is 1Ω. If the specified Load Impedance is less than 1Ω, the system will adjust the Load Impedance to 1Ω automatically.

Start Phase upper limit = 360.0°

The Start Phase upper limit is 360.0°. If the specified Start Phase is greater than 360.0°, the system will adjust the Start Phase to 360.0° automatically.

Start Phase lower limit = -360.0°

The Start Phase lower limit is -360.0°. If the specified Start Phase is less than -360.0°, the system will adjust the Start Phase to -360.0° automatically.

(denotes the parameter, the content of which will vary according to the setting.)**

Troubleshooting

1. If the screen does not turn on even if the generator is on, please follow the steps below:

- ①、Check if the power is correctly connected
- ②、Check if the power switch is really on.
- ③、Restart the instrument after the steps above.
- ④、if it does not work correctly, contact **RIGOL** for our service.

2. If the settings are correct but no waveform is generated, please follow the steps below:

- ①、Check if the Signal Line is correctly connected to the Output terminal.
- ②、Check the BNC if it can work correctly.
- ③、Check the **Output** button, if it is turned on.
- ③、Set the **Power On** setting **Last** when all the above steps have been finished.
Restart the computer.

3. If U Disk can not be detected, please follow the following steps:

- ①、Check if the U Disk can work properly.
- ②、Make sure that the U Disk used is a Flash Type. Portable Hard Disk can not be used in this instrument.
- ④、Restart the instrument, and insert the U Disk again.
- ⑤、If it still can not work properly, please contract the local **RIGOL** Support Center.

Chapter 5 : Support & Service

Warranty (DG3000 Series Function/ Arbitrary Waveform Generator)

RIGOL warrants that the products it manufactures and sells will be free from defects in materials and workmanship for a period of three (3) years from the date of shipment from an authorized RIGOL distributor. If a product proves defective within the respective period, RIGOL will provide repair or replacement as described in the complete warranty statement.

To arrange for service or obtain a copy of the complete warranty statement, please contact your nearest RIGOL sales and service office.

Rigol do not provide any other warranty items except the one being provided by this summary and the warranty statement. The warranty items include but not being subjected to the hint guarantee items related to tradable characteristic and any particular purpose.

Rigol will not take any responsibility in cases regarding to indirect, particular and ensuing damage.

Contact RIGOL

If you meet any ambiguous problem during the use of our products, please contact Rigol Technologies, Inc. or contact your local distributor.

Domestic: Please call

Tel: (8610)80706688

Fax: (8610)80720067

9:00 am –5: 00 pm from Monday to Friday

Or by e-mail:

support@rigol.com

Or mail to:

RIGOL Technologies, Inc.

156# CaiHe Village, ShaHe Town, ChangPing, Beijing, China

Post Code: 102206

Overseas: Contact local **RIGOL** distributor or sales office.

For a list of worldwide service centers, visit our web site: www.rigol.com

Chapter 6 : Appendix

Appendix A: Specifications

All these specifications apply to the DG3000 Series Function/ Arbitrary Waveform Generator unless otherwise explanation. To reach these specifications, two conditions must be met first:

- The instrument must have been operating continuously for more than 30 minutes within the specified operating temperature.
- You must perform the Self-Cal (Calibrate) operation if the operating temperature changes by more than 5°C.

All these specifications are guaranteed unless noted "typical"

Specifications

Frequency Characteristic (DG3121A)	
Waveforms	Sine, Square, Ramp, Triangle, Pulse, Noise, DC, Arb
Sine	1 μ Hz to 120MHz
Square	1 μ Hz to 120MHz
Pulse	500 μ Hz to 36MHz
Ramp	1 μ Hz to 1MHz
White Noise	50MHz bandwidth (-3dB)
Frequency Characteristic (DG3101A)	
Waveforms	Sine, Square, Ramp, Triangle, Pulse, Noise, DC, Arb
Sine	1 μ Hz to 100MHz
Square	1 μ Hz to 100MHz
Pulse	500 μ Hz to 36MHz
Ramp	1 μ Hz to 1MHz
White Noise	40MHz bandwidth (-3dB)
Frequency Characteristic (DG3061A)	
Waveforms	Sine, Square, Ramp, Triangle, Pulse, Noise, DC, Arb
Sine	1 μ Hz to 60MHz
Square	1 μ Hz to 60MHz
Pulse	500 μ Hz to 30MHz
Ramp	1 μ Hz to 1MHz
White Noise	30MHz bandwidth(-3dB)
Resolution	1 μ Hz
Accuracy	Within 90 days 10 ppm Within 1 year 20 ppm, 18°C - 28°C
Temperature index	< 2 ppm/°C

Sine Wave Spectral Purity			
Harmonic Distortion		< 1 Vpp	> 1 Vpp
	DC to 20 kHz	-70 dBc	-70 dBc
	20 kHz to 100 kHz	-65 dBc	-60 dBc
	100 kHz to 1 MHz	-50 dBc	-45 dBc
	1 MHz to 10 MHz	-40 dBc	-35 dBc
Total Harmonic Distortion	DC to 20 kHz	0.04%	
Spurious (non-harmonic)	DC to 1 MHz	< -70 dBc	
	1 MHz to 10 MHz	< -70 dBc + 6 dB/octave	
Phase Noise	10kHz Offset -115 dBc / Hz, typical		

Square Wave Characteristic	
Rise/Fall Time	< 8 ns (10% to 90%)
Overshoot	< 2%
Duty Cycle	20% to 80% (to 10 MHz)
Asymmetry(below 50% Duty Cycle)	1% of period+ 5ns
Jitter	300ps + 100ppm of period

Ramp Wave Characteristics	
Linearity	< 0.1% of peak output
Symmetry	0% to 100%

Pulse Wave Characteristics	
Pulse Width	2000s max period;8ns min period; 5ns resolution
Variable Edge Time	5ns to 1ms
Overshoot	< 2%
Jitter	300ps + 0.1 % of the period

Arb Wave Characteristics	
Frequency Range	1μHz to 25MHz
Waveform Length	2 to 512 K points

RIGOL

Amplitude Accuracy	14 bits (including sign)
Sample Rate	100MSa/s
Minimum Edge Time	10ns
Jitter (RMS)	2.5 ns + 30ppm
Non-Volatile Storage	4 waveforms

Output Characteristics

Amplitude	10 mVpp - 10 Vpp (50 Ω) 20 m Vpp - 20 Vpp (High Z) [Note 1]
Amplitude Accuracy (1 kHz)	± 1% of setting ± 1 mVpp
Amplitude Flatness (sinewave relative to 1 kHz)	< 10 MHz 0.1 dB (± 1%) 10 MHz to 80 MHz 0.15 dB (± 1.5%) 80 MHz to 120 MHz 0.4 dB (± 4.0%)

DC Offset

Range (peak AC+DC)	±5V (50Ω) ±10 V (High Z)
Accuracy	± 2% of the Offset Setting ± 0.5% of the Amplitude ± 2mV

Waveform Output

Impedance	50 Ω typical
Isolation	42 Vpk max. to Earth
Protection	Short-circuit protected; Overload relay automatically disables main output

AM Modulation

Carrier Waveforms	Sine, Square, Ramp, Arb
Source	Internal/ External
Modulating Waveforms	Sine, Square, Ramp, Noise, Arb (2mHz to 20kHz)
Depth	0% - 120%

FM Modulation

Carrier Waveforms	Sine, Square, Ramp, Arb
-------------------	-------------------------

Source	Internal/ External
Modulating Waveforms	Sine, Square, Ramp, Noise, Arb (2mHz to 20kHz)
Frequency Deviation	DC to 50 MHz [Note 2]
PM Modulation	
Carrier Waveforms	Sine, Square, Ramp, Arb
Source	Internal/ External
Modulating Waveforms	Sine, Square, Ramp, Noise, Arb (2mHz to 20kHz)
Phase Deviation	0 to 360°
FSK Modulation	
Carrier Waveforms	Pulse
Source	Internal/ External
Modulating Waveforms	50% duty cycle square (2mHz to 100kHz)
PWM Modulation	
Carrier Waveforms	Pulse
Source	Internal/ External
Modulating Waveforms	Pulse width 0% to 100%
Sweep	
Carrier Waveforms	Sine, Square, Ramp, Arb
Type	Linear or Logarithmic
Direction	Up or Down
Sweep Time	1 ms to 500 s \pm 0.1%
Source	Internal/External/Manual
Marker	Falling edge of Sync signal (Programmable Frequency)
Burst	
Waveforms	Sine, Square, Ramp, Pulse, Noise, Arb
Types	count (1 to 50,000 periods) , infinite, gated
Start Phase	-360° to +360°
Internal Period	1 μ s – 500 s \pm 1%
Gate Source	External Trigger
Trigger Source	Internal/External/Manual

Rear Panel Connector	
External AM Modulation	± 5 Vpk = 100% modulation 5k Ω input impedance
External Trigger	TTL-compatible

Trigger Input	
Input Level	TTL-compatible
Slope	Rising or falling (selectable)
Pulse Width	> 100 ns
Input Impedance	> 10 k Ω , DC coupled
Linear Sweep	< 500 μ s (typical)
Latency Sweep	< 500 ns (typical)

Trigger Output	
Level	TTL-compatible into >1k Ω
Pulse Width	> 400ns typical
Output Impedance	50 Ω , typical
Maximum Rate	1 MHz

[Note 1]:

The setting range of the amplitude (50 Ω):

If the output frequency \leq 10MHz, then the amplitude range: 10mVpp~10Vpp

If the output frequency \leq 80MHz, then the amplitude range: 10mVpp~5Vpp

If the output frequency >80MHz, then the amplitude range: 10mVpp~2.5 Vpp

The setting range of the amplitude (High Z):

If the output frequency \leq 10MHz, then the amplitude range: 20mVpp~20Vpp

If the output frequency \leq 80MHz, then the amplitude range: 20mVpp~10Vpp

If the output frequency >80MHz, then the amplitude range: 20mVpp~5 Vpp

[Note 2]:

The values are dissimilar for different types, the type of 60MHz is 30MHz, while the type of 100MHz is 50MHz.

General Specifications

Display	
Type	4.0 inch STN LCD
Resolution	320 Horizontal x RGB X 240 Vertical
Grey Degree	64 color
Contrast (typical)	150 : 1
Light (typical)	300 nit

Power	
Supply	100-240 VAC _{RMS} , 45-440Hz, CAT II
Consumption	Less than 50W
Fuse	2A, T Level , 250V

Environment	
Temperature Range	Operation: 10°C~+40°C
	Non-operation: -20°C~+60°C
Cooling	Mandatory Fan cooling
Humidity Range	Below +35°C: ≤90% relative humidity
	+35°C~+40°C: ≤60%relative humidity
Height Range	Operation : below 3,000m
	Non-operation: below 15,000m

Instrument Specifications		
Dimension	Width	232mm
	Height	107.5mm
	Depth	365+9.5mm(9.5 mm is the BNC Depth)
Weight	Package excluded	3.56Kg
	Package Included	5.10Kg

IP Protection
IP2X

Calibration Interval
One year suggested

Appendix B: DG3000 Series Accessories

Standard Accessories:

- A Power Cord that fits the standard of the destination country.
- A User Manual
- A product Warranty card

Optional Accessories:

- A BNC Cable
- A RS-232 Cable
- Digital Output Module
- Data line

All the accessories (standard and optional) are available by contacting your local RIGOL office.

Appendix C: General Care and Cleaning

General Care

Do not store or leave the instrument in the place where the LCD display will be exposed to direct sunlight for long periods of time.



CAUTION: To avoid damage to the instrument or probes, do not expose them to sprays, liquids, or solvents.

Cleaning

Check the Instrument and Probe frequently according to the operation conditions; follow the steps below to clean the exterior surface of the instrument:

1. Remove loose dust on the outside of the instrument and probes with a lint-free cloth. Take care to avoid scratching the clear plastic display filter.
2. Use a soft cloth dampened with water to clean the instrument. Please disconnect the power. To avoid damage to the surface of the instrument or probes, do not use any abrasive or chemical cleaning agent.



Warning: before restarting the instrument, make sure that the instrument is dry to avoid any short-circuit or body damage because of the moisture.
